

ITEM NUMBER	PART NUMBER	QUANTITY	REMARKS	ITEM NUMBER	PART NUMBER	QUANTITY	REMARKS	ITEM NUMBER	PART NUMBER	QUANTITY	REMARKS
FIGURE	NO. DE PIÈCE	QUANTITÉ	NOTES	FIGURE	NO. DE PIÈCE	QUANTITÉ	NOTES	FIGURE	NO. DE PIÈCE	QUANTITÉ	NOTES
FIGURA	NO. DE PIEZA	CANTIDAD	NOTAS	FIGURA	NO. DE PIEZA	CANTIDAD	NOTAS	FIGURA	NO. DE PIEZA	CANTIDAD	NOTAS
BILD-NUMMER	TEIL-NUMMER	STÜCKZAHL	HINWEISE	BILD-NUMMER	TEIL-NUMMER	STÜCKZAHL	HINWEISE	BILD-NUMMER	TEIL-NUMMER	STÜCKZAHL	HINWEISE
1	475543	1	(1-14)	81	429266	1		154	474604	1	(154-155)
2	431441	1		82	430990	1		155	430713	1	
3	432135	1		83	430231	1		156	431167	1	
4	426752	1		84	430228	1		157	431657	2	
5	475545	1		85	475157	1	(85-95)	158	430192	1	
6	430716	1		86	474959	1		159	427888	1	
7	432799	1	(A & B)	87	430227	1		160	431010	4	
8	432928	2		88	475156	1		161	431688	4	
9	432631	1		89	431221	1		162	475366	1	(162-165)
10	432437	5		90	430880	1		163	428336	1	
11	432503	1		91	474932	1		164	432306	1	
12	475544	1		92	431699	1		165	432523	2	
13	432629	1		93	430385	1		166	431537	1	
14	432630	1		94	431359	1		167	431268	1	
15	432307	3		95	430229	1		168	431271	1	
16	432308	1		96	431669	1		169	430545	1	
17	430800	2		97	431596	1		170	431534	1	
18	429851	1		98	430848	1		171	431639	1	
19	430877	2		99	474455	1	(99-100)	172	475058	1	
20	430876	2		100	430743	1		173	430885	1	
21	431416	2		101	-	-		174	431685	3	
22	430878	2		102	430798	1		175	432890	1	(A)
23	475537	1		103	475503	1	(103-106)	176	432404	3	(B,C,D,E,F)
24	431705	4		104	475454	1		177	431078	1	
25	431640	2		105	432434	4		178	475491	1	
26	475320	1	(26-28)	106	432443	1		179	475615	1	(178-207)
27	430694	1		107	432686	1		180	475569	1	
28	475326	1		108	432687	1		181	431164	1	
29	431689	1		109	475782	1		182	431165	1	
30	432975	1		110	475760	1	(109-129)	183	430761	2	
31	431022	1		111	432613	1	(217-218)	184	430750	2	
32	475167	1	(32-40)	112	431636	1	(110-115)	185	432582	1	
33	431702	1		113	425672	1		186	430752	1	
34	427993	1		114	432896	1		187	430753	1	
35	427273	1		115	432930	3		188	430755	1	
36	431003	1		116	432912	1		189	430756	1	
37	427278	1		117	432650	1		190	430759	1	
38	429946	1		118	432913	1		191	430757	1	
39	431370	1		119	432645	1		192	430764	1	
40	431368	1	(41-45)	120	432648	1		193	430768	6	
41	475168	1		121	432647	1		194	430747	1	
42	432523	1		122	432646	1		195	474625	1	
43	431703	1		123	433025	1		196	430762	1	
44	427690	1		124	432931	2		197	430765	1	
45	431369	1		125	432932	2		198	474624	1	
46	430925	1		126	432932	2		199	430850	2	
47	431690	3		127	432657	2		200	430849	1	
48	431658	1		128	432914	1		201	474623	1	
49	432117	9		129	433029	1		202	430767	1	
50	429776	6		130	432836	1	(A & C)	203	430751	4	
51	428746	2		131	432835	1	(D)	204	431758	1	
52	431642	3		132	430680	2		205	430886	1	
53	430191	1		133	430807	2		206	430766	1	
54	430190	1		134	475405	1	(132-134)	207	475354	1	
55	475190	1	(55-58)	135	432413	1		208	430749	1	
56	432536	2		136	430282	1		209	474622	1	
57	431408	1		137	432827	1	(A & C)	210	-	-	
58	432210	1		138	432828	1	(B)	211	474945	1	
59	429548	2		139	432826	1	(D)	212	473645	1	(212-214)
60	432878	1		140	432856	1	(E)	213	429835	1	
61	475779	1		141	432848	1	(F)	214	431756	2	
62	432879	1		142	475623	1	(136-137)	215	431678	2	
63	431655	8		143	430320	1		216	432913	1	
64	430184	1		144	430991	1	(A,C,D,E,F)	217	432958	1	
65	432876	1		145	432916	1	(B)	218	429266	1	
66	431706	4		146	431174-8	1		219	431688	1	
67	431691	4		147	430203	1			431125	1	
68	431614	1		148	429650	1					
69	430684	1		149	430202	1					
70	474587	1		150	430887	1					
71	475778	1		151	430840	1					
72	474974	1		152	473935	1					
73	475773	1		153	430399	1					
74	431683	1		154	431092	2					
75	431686	2		155	430327	1					
76	430992	2		156	430830	1					
77	430993	1		157	432898	1					
78	430197	6		158	431684	2					
79	430196-8	1		159	475548	1					
80	474958	1		160	431687	2					

P/N 432894
0-10-82

INDEX A, C - English/French D - English
 INDEX English/Français E - Spanish
 INDEX B - German Español
 INDICES Deutsch F - Italian
 Italiano

FARMLite

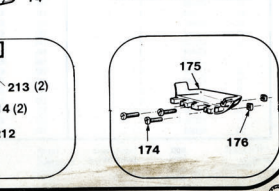
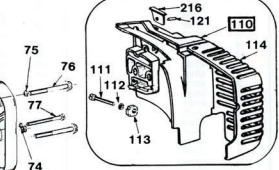
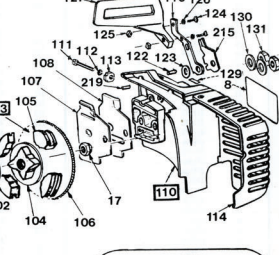
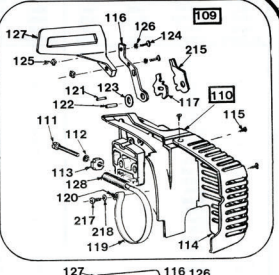
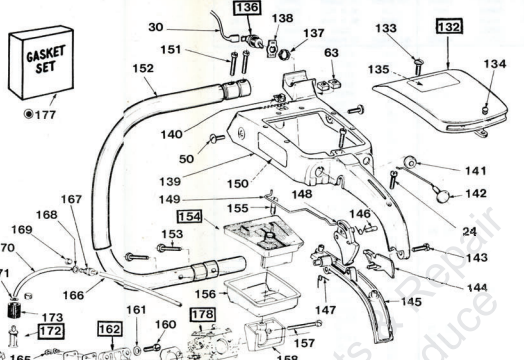
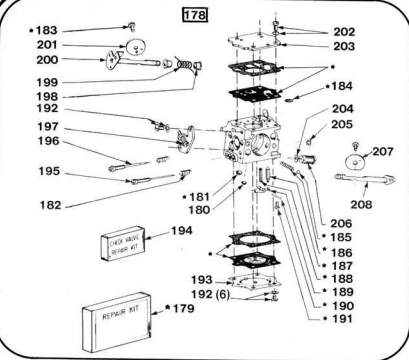
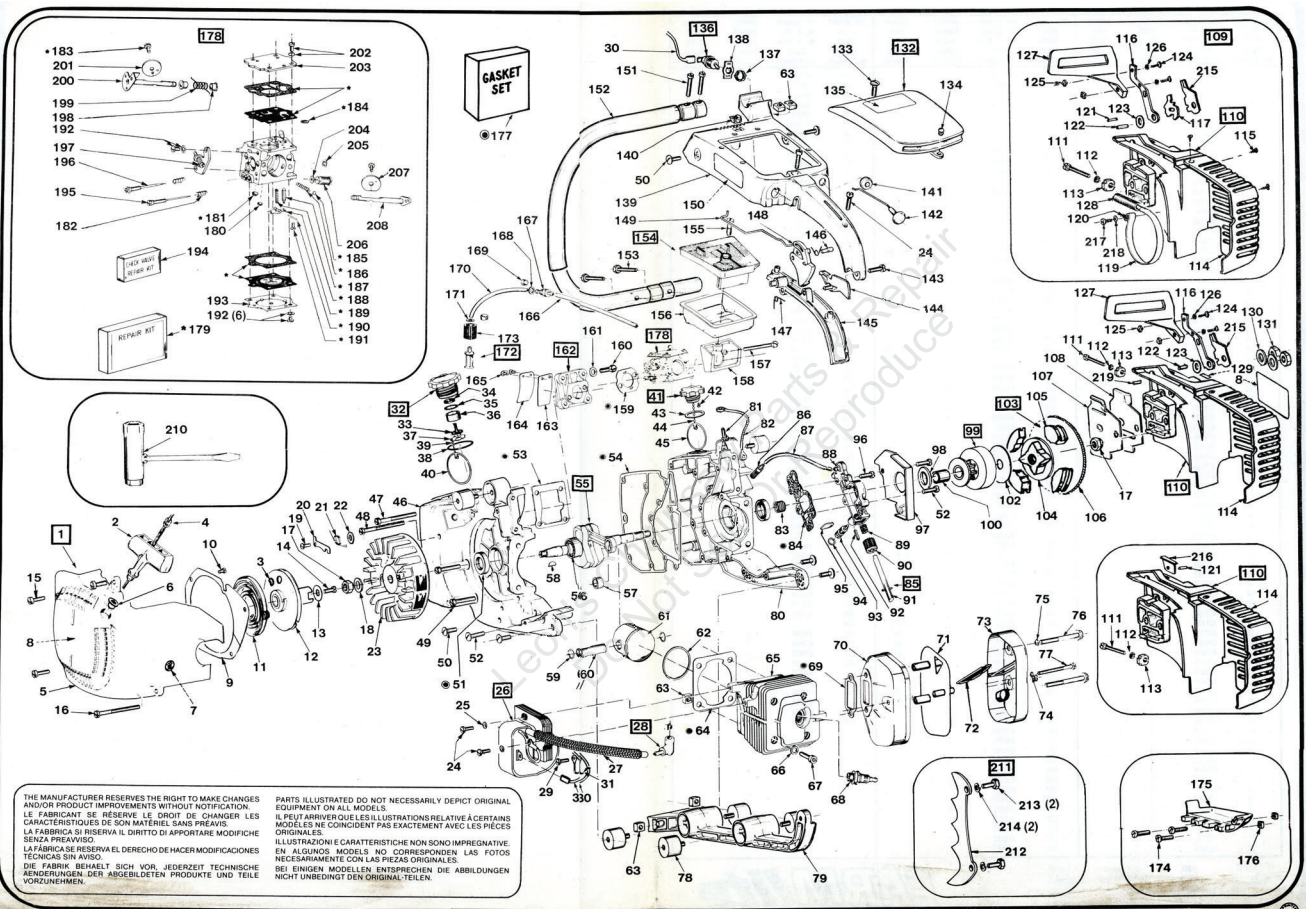

THE MANUFACTURER RESERVES THE RIGHT TO MAKE CHANGES AND/OR PRODUCT IMPROVEMENTS WITHOUT NOTIFICATION.
 LE FABRICANT SE RÉSERVE LE DROIT DE CHANGER LES CARACTÉRISTIQUES DE SON MATÉRIEL, SANS PRÉAVIS.
 LA FABBRICA SI RISERVA IL DIRITTO DI APPORTARE MODIFICHE TECNICHE SENZA PREAVVISO.
 LA FÁBRICA SE RESERVA EL DERECHO DE HACER MODIFICACIONES TÉCNICAS SIN AVISO.
 DIE FABRIK BEHÄLT SICH VOR JEDERZEIT TECHNISCHE ÄNDERUNGEN, DER ABGEBILDETEN PRODUKTE UND TEILE VORZUNEHMEN.

PARTS ILLUSTRATED DO NOT NECESSARILY DEPICT ORIGINAL EQUIPMENT ON ALL MODELS.
 IL PEUT ARRIVER QUE LES ILLUSTRATIONS RELATIVE À CERTAINS MODELES NE COINCIDENT PAS EXACTEMENT AVEC LES PIÉCES ORIGINALES.
 ILLUSTRAZIONI E CARATTERISTICHE NON SONO IMPRGNATIVE IN ALCUNIS MODELS NO CORRESPONDONO LAS FOTOS NECESARIAMENTE CON LAS PIEZAS ORIGINALES.
 BEI EINIGEN MODELLEN ENTSPRECHEN DIE ABBILDUNGEN NICHT UNBEDINGT DEN ORIGINAL-TEILEN.