

HOMELITE®

OWNERS MANUAL

250 CHAINSAW

Leon's Chainsaw Parts & Repair
Do Not Sell Or Reproduce



SECOND EDITION
PART NO. 18455
Printed in U.S.A.
Price \$1.00

NOTE: See back page for Servicing Dealer Information.

POWERHEAD, BAR & CHAIN COMB 2
SYMBOL DEFINITIONS 2
SAFETY PRECAUTIONS 3
 Kickback, Push and Pull 5
 Safe-T-Tip® Anti-Kickback Device 5
 Devices To Reduce Injuries
 From Kickback 6
 Comparison Chart 7
 How To Maintain Control 8
 Facts About the Chain Saw 11
 Vibration Isolation 11
SAFE•T•TIP® 11
 Hearing Protectors 11
 Chain Brake 11
 Your Physical Condition 11
 Protective Equipment and Supplies 12

SECTION 1 - PREPARATION 13
 Installing SAFE•T•TIP® Device 13
 Bar and Chain Assembly 14

CONTENTS

Chain Tension 14
 Daily Bar and Chain Care 15
 Filling the Tanks 16
 Starting and Stopping 17

SECTION 2 - THE WORKING AREA . 18
 Work Area Precautions 18
 Handling and Securing the Saw 19
 Unusual Conditions 19

SECTION 3 - TECHNIQUES 20
 Bucking, Limbing, Pruning 20
 Variations 20
 Spring Poles 21
 Boring 21
 Treeing Felling Techniques 22

SECTION 4 - MAINTENANCE AND REPAIR 24
 Homelite® RAKER III® Saw Chain 24
 Filing Equipment 24
 How to File Cutters 24
 Corrective Filing 25
 Raker (Depth Gauge) Clearance 26
 Guide Bar Maintenance 26
 Clutch and Sprocket 27
 Chain Brake 27
 Air Filter 27
 Carburetor 28
 Fuel System 29
 Chain Oil Systems 30
 Cooling & Exhaust 31
 Spark Plug 31
 Muffler 31
 Starter 32
 Storage 33

POWERHEAD, BAR AND CHAIN COMBINATIONS

LENGTH OF BAR AND STYLE OF TIP	GUIDE BAR NO.	CHAIN PART NO.	CHISEL TYPE NO.
16" SPROCKET TIP	PT-16321-G6 SP-16321-H6	D1-92067-FB	32-LE50-67
18" SPROCKET TIP	PT-18321-G6	D1-92073-FB	32-LE50-73
20" SPROCKET TIP	PT-20321-G6 SP-20321-H6	D1-92079-FB	32-LE50-79

SYMBOL DEFINITIONS



THIS SYMBOL INDICATES DANGER OR WARNING.



DANGER! BEWARE OF KICKBACK.



AVOID BAR NOSE CONTACT.



THE SAFE•T•TIP® DEVICE ON YOUR BAR NOSE PREVENTS KICKBACK.



READ YOUR PRODUCT LITERATURE.



WEAR HEARING AND EYE PROTECTION DEVICES.



DO NOT USE ONE-HANDED.



HOLD SAW PROPERLY WITH BOTH HANDS.



DIAGONAL LINE ACROSS A SYMBOL "PROHIBITED" OR "TO BE AVOIDED."

SAFETY PRECAUTIONS FOR CHAIN SAW USERS

PRECAUTIONS AGAINST KICKBACK



WARNING: KICKBACK may occur when the nose or tip of the guide bar touches an object. Tip contact, in some cases, may cause a lightning fast reverse reaction, kicking the guide bar up and back towards the operator.

WARNING: PINCHING the saw chain along the top of the guide bar may push the guide bar rapidly back towards the operator. The pinch may occur when the wood closes around the chain in the cut.

Either of the above reactions, **KICKBACK** or **PINCH**, may cause you to lose control of the saw and could result in **SERIOUS PERSONAL INJURY**. When a push has caused the operator to lose control, it is possible for a kickback to occur as a secondary reaction.

Do not rely exclusively upon the safety devices built into your saw to protect you from injury. As a chain saw user, you should do the following to avoid accident and injury:

- Keep **SAFE•T•TIP®** Anti-kickback Device properly mounted on the guide bar. It prevents kickback.
- Get a basic understanding of kickback so you can reduce or eliminate the element of surprise. Surprise can contribute to accidents.
- Keep a firm grip on the saw with both hands when the engine is running. The right hand should be on the rear handle and the left hand on the front handle. Use a firm grip with thumbs and fingers encircling the handles. A firm grip will help you to maintain control of the saw if kickback occurs. Don't let go.
- Be sure the area in which you are cutting is free from obstructions. To avoid kickback, if you remove the **SAFE•T•TIP** Device for a specific cut, do not let the chain at the tip of the guide bar contact a log, branch or any other obstruction while you are operating the saw.
- Keep your body to the left of the line of cut.
- Always bring the saw up to speed before letting the chain touch the wood. Once wood contact is made, keep cutting at steady speed. Do not slow down, then speed up or the saw may pull you off balance.
- Do not overreach or cut above shoulder height. You cannot maintain proper control in these positions.
- Follow Homelite's sharpening and maintenance instructions for the saw chain. Improper maintenance may defeat the safety features designed into your saw.
- Use only the bars and chains specified by Homelite. Other bars and chains may have greater kickback potential.
- Keep up to date with the latest technology in chain saw safety devices and equipment. Contact Homelite Manager of Customer Relations for information.

(Address is on back page.)

OTHER BASIC SAFETY PRECAUTIONS

BASIC PRECAUTIONS FOR PERSONAL SAFETY

- Use safety footwear, snug-fitting clothing, and eye, hearing and head protection.
- Wear non-slip gloves to improve your grip. Do not wear scarfs, jewelry, or neckties which could be drawn into the engine or catch on the chain or underbrush.
- Always hold the chain saw with both hands when the engine is running. Use a firm grip with thumbs and fingers encircling the chain saw handles.
- Guard against the effects of a long or continuous exposure to noise, such as involved in the operation of a chain saw. Hearing protection devices are available from you local Homelite Dealer.
- Never operate a chain saw when you are fatigued.
- Keep all parts of your body away from the saw chain when the engine is running.

BASIC PRECAUTIONS WITH CHAIN SAWS

- Always carry the chain saw with the engine stopped, the guide bar and saw chain to the rear, and the muffler away from your body. When transporting your chain saw, use the appropriate guide bar scabbard.
- Always use caution when handling fuel. Move the chain saw at least 10 feet (3 m) from the fueling point before starting the engine.
- Be ready to hold up the saw so it will not drop onto your leg when the cut is finished.
- Never make one-hand cuts, because the saw may skate out of control along the surface of the wood, or because kickback, pinch, push or other reactions cannot be controlled as well with any one hand.
- Never let anyone use your chain saw who has not received adequate instructions in its proper use. This applies to rentals as well as privately owned saws.
- Keep the handles dry, clean and free of oil or fuel mixture.

- Before you start the engine, make sure the saw chain is not contacting anything.
- Shut off the engine before setting down the saw. Do not leave the engine running unattended.
- Operate the chain saw only in well ventilated areas.
- Be sure that the chain stops moving when the throttle control is released.

BASIC PRECAUTIONS ABOUT MAINTENANCE

- Never operate a chain saw that is damaged, improperly adjusted, or is not completely and securely assembled. Be sure that the saw chain stops moving when the throttle control trigger is released.
- All chain saw service, other than items in the Owner's Manual maintenance instructions, should be performed by competent chain saw service personnel. (If improper tools are used to remove the flywheel or clutch, or if an improper tool is used to hold the flywheel in order to remove the clutch, structural damage to the flywheel could occur which could subsequently cause the flywheel to burst.)

BASIC PRECAUTIONS IN CUTTING/WORK AREA

- Do not operate a chain saw in a tree unless you have been specifically trained to do so.
- Keep bystanders and animals out of the work area.
- Never start cutting until you have a clear work area, secure footing, and a planned retreat path from the falling tree.
- Use extreme caution when cutting small size brush and saplings, because slender material may catch the saw chain and be whipped toward you or pull you off balance.
- When cutting a limb that is under tension, be alert for springback so that you will not be struck when the tension in the wood fibers is released.

KICKBACK, PUSH, AND PULL

and how these reaction forces are best controlled.

NOTICE

When properly installed on your saw, the **SAFE•T•TIP®** Anti-Kickback Device will prevent kickback. The **Raker III™** saw chain on your saw is added protection, helping you to control the reaction forces described below when the **SAFE•T•TIP** device must be removed. However, if you remove the **SAFE•T•TIP** device temporarily, even for just one cut, you must rely on the techniques described in this owner's manual as your first line of defense and control.

THE REACTION FORCES

In the operation of a chain saw, engine torque is transferred to the chain. This energy is then used to cut wood. But to every force (action) there is always a reaction force in the opposite direction. Thus if the chain contacts wood or any other obstruction where the chain is moving away from the operator, the operator will feel the saw being pushed toward him. And when the work contact is made on the underside of the bar where the chain is moving toward the operator, the person will feel the saw being pulled away from him.

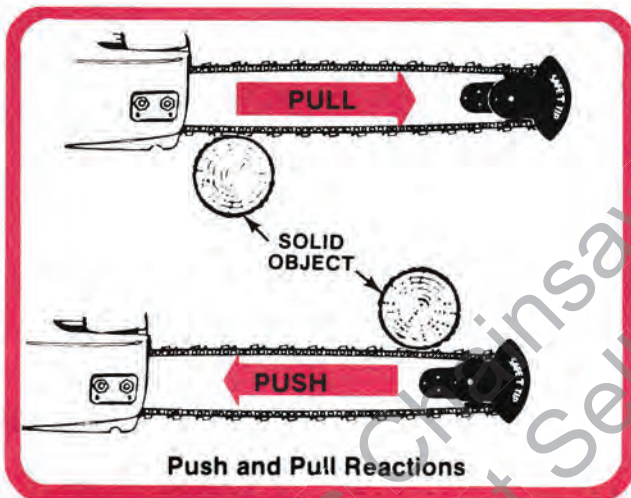

THE **SAFE•T•TIP** DEVICE DOES NOT PREVENT OR REDUCE PUSH AND PULL REACTION.



SAFE•T•TIP® ANTI-KICKBACK DEVICE

You still have to control PULL and PUSH as well as the tendency of the chain to slide along the work rather than penetrate it. But, the **SAFE•T•TIP** Device really does prevent kickback from happening, because it covers the tip of the bar where kickback is generated. Inexperienced persons should never attempt any kind of cutting where the Device would have to be removed from the bar tip.

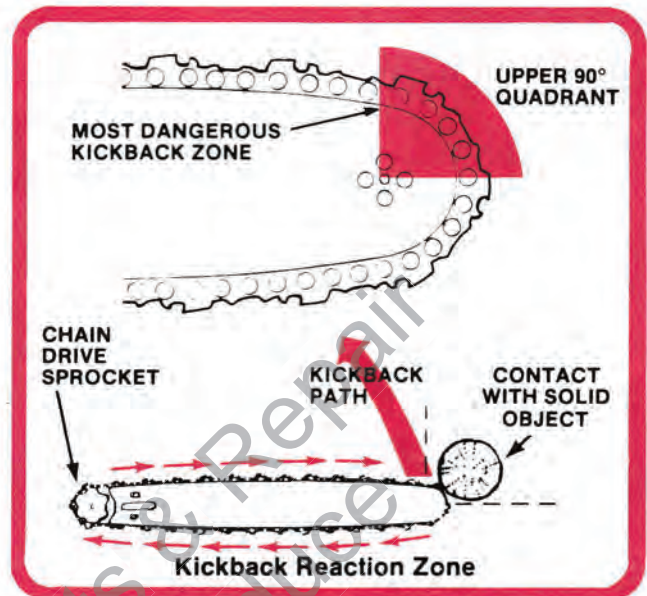

KICKBACK is another reaction, the most dangerous of these reactive forces. It occurs only when solid contact with the moving chain is made at the upper quadrant of the bar nose. A violent kickback will occur any time the chain hits a solid object (or takes too large a cut) while rounding this top quadrant of the bar nose. For the instant that the chain is stopped cold, the engine drives the guide bar to rotate inside the chain loop. This results in a pinwheeling rotation of the chain, the saw, and the bar during which the bar nose *kicks back in an arc towards the operator*. This is **KICKBACK** the most dangerous of the reactions which can cause loss of control. When properly installed on a saw, a **SAFE•T•TIP** anti-kickback device prevents kickback. But it is not a general insurance against "accidents" with a chain saw.

DEVICE TO PREVENT INJURIES FROM KICKBACK

Those users, such as professional loggers, who may need to draw the tip through the cut, make boring cuts, or cut logs bigger than the bar length should replace the Device as soon as those cuts are complete. When cutting with the Device removed, the user must rely on careful use of the proper techniques as shown in the manual to avoid kickback. With proper care to keep the Device properly mounted and tightened on the bar, the **SAFE•T•TIP** Device will prevent kickback for the life of the unit. If allowed to loosen, it may catch the chain. Replace only if damaged.

DEVICES TO REDUCE INJURIES FROM KICKBACK



RAKER III® LOW KICKBACK SAW CHAIN

The three rakers (depth gauges) ahead of each cutter can minimize the force of a kickback reaction by preventing the cutters rounding the tip of the bar from digging in too deeply at the kickback zone. Raker III chain is a

key factor enabling your saw to meet the ANSI standard which requires that a saw kick back no more than 45 degrees under simulated conditions. These conditions are intended only to provide reference numbers for comparison (like EPA mileage ratings which may not represent actual fuel economy). A rating below 45 degrees *does not* mean the saw cannot kick much higher in actual use.

Under some conditions Raker III saw chain may not cut as smoothly or quickly as conventional chain. When cutting logs with smooth bark, the chain may tend to skid or slide along the work before penetrating into a cut. Top performance of Raker III chain is obtained by frequent, precise chain maintenance.

Properly maintained Raker III chain may lose a bit of its kickback-reducing ability with every sharpening. This is due to the increase in space between rakers and teeth as the cutters are filed back. The chain will be rough-cutting, "grabby," and more kickback-prone if the cutters have a forward hook shape, rakers are filed too low or have an improper contour.

Generally: a) Dullness does not increase the kickback potential of a chain very much, b) improperly sharpened chain, especially the too-low filing of the rakers, may have a significantly higher kickback potential, and c) even with care to maintain the proper cutter angles and raker depths, the kickback potential can increase slightly with each filing.

HOMELITE® GUIDE BARS

Generally, guide bars with small radius tips have somewhat lower kickback potentials, but at the sacrifice of both cutting efficiency and durability. Therefore Homelite equips only electric saws with the narrow tip bars.

Homelite gasoline saws meet the kickback-reduction requirements of ANSI B175.1 without need for small radius tip bars.

When making a replacement be sure to order one of the Homelite bars listed for your saw in this owner's instruction. The proper size SAFE•T•TIP Device comes installed on the bar. Bars of other manufacture which lack provision for mounting this kickback preventing **Device** should not be used.

The ability of a kickback-reduction guide bar to reduce kickback does not normally diminish with either wear or normal use. But the owner's manual instructions for bar maintenance should be followed to prevent chain damage and preserve saw performance.

FRONT HAND GUARD

Your saw has a factory installed front hand guard. Do not remove this guard or replace it with a substitute (which may not offer the same level of protection). Maintain the guard in good condition. Do not let it snag in the underbrush. Do not use the guard as a hand grip. Replace it if damaged or broken.

CHAIN BRAKE

Even if you purchased a chain brake-equipped model, Homelite has supplied a SAFE•T•TIP® anti-kickback device for it. This is because a chain brake does not prevent kickback any more than a seat belt prevents collisions. A chain brake can only stop chain rotation. For your safety, rely on the SAFE•T•TIP **Device** to prevent kickback. Also depend on using the proper grip and stance, and the safe cutting techniques recommended in your owner's manual to control the forces which tend to push or pull you and the saw during cutting.

At its best, a chain brake offers only partial protection against injury from kickback. In some situations it may be impossible for the brake mechanism to stop the chain before the saw blade reaches the operator. This is especially true in situations where the operator is positioned in close proximity to the saw blade.

A chain brake is not like a fire extinguisher which can be certified to work for a certain time. Too many things like breakage or wear, dirt, dust, sawdust, chain oil, and temperature changes in the chain saw's environment can reduce the chain brake's ability to stop the chain. The best chance you can give the brake to react effectively is to keep it clean. Even with daily cleaning of the mechanism, the dependability of a chain brake to perform under field conditions cannot be certified or even gauged. Keep the SAFE•T•TIP **Device** on your saw's guide bar, and use proper cutting techniques.

COMPARISON CHART

FUNCTION	EFFECT, IF ANY, UPON PERFORMANCE OF CHAIN SAW	EFFECT IF REMOVED	EFFECT OF BOTH NORMAL AND IMPROPER USE & CARE	EFFECT OF A PRODUCT SUBSTITUTE
----------	---	-------------------	---	--------------------------------

DEVICE TO PREVENT INJURIES FROM KICKBACK

BAR-TIP GUARD (SAFE•T•TIP® Anti-kickback device is factory-installed on all Homelite bars.)

Covers kickback-generating zone of the bar tip to prevent kickback from happening.	Prevents (a) drawing of the bar tip through the cut, (b) boring and (c) cuts where tip is buried.	Cannot prevent kickback if removed from the bar.	No loss of protection if kept properly tight. Loose device can catch the chain.	To be as effective as the SAFE•T•TIP Device, similar products must fit just as well over the bar tip.
--	---	--	---	---

DEVICES TO REDUCE INJURIES FROM KICKBACK

LOW-KICKBACK CHAIN (Homelite's Chain in this category is Raker III® Chain.)

Control depth of cutter penetration at the bar tip to reduce force of a potential kickback.	Low-kickback design may compromise cutting speed. Needs proper care to preserve top speed.		May be slight increase of potential kickback force as teeth are filed back. Can be grabby and more dangerous if improperly filed.	Other chains may have greater potential kickback force and may not cut as well.
---	--	--	---	---

REDUCED-KICKBACK GUIDE BAR (Most Homelite models do not use reduced-kickback guide bars.)

Small radius bar tip lowers potential kickback force and may provide a smaller kickback zone at bar tip.	May tend to have shorter life than wider tip bars, and may reduce the cutting rate in some situations		No loss of protection if properly maintained, slow or off-line cutting if not properly maintained. Rail wear, changing effective tip radius, may affect protection.	Kickback potential may increase.
--	---	--	---	----------------------------------

CHAIN BRAKE (Kits and special "SL" model chain saws with chain brakes are available for many Homelite saw models.)

Intended to stop chain in time to reduce injury from a kickback.	Adds weight and bulk to the saw model. May snag in the brush. May activate unintentionally.	Chain will not be stopped by a brake.	May fail to stop chain quickly enough - even with normal use and care. Increase in stopping time likely to go undetected.	May not function as intended.
--	---	---------------------------------------	---	-------------------------------

FRONT HAND GUARD (Front hand guards are provided on all Homelite saws.)

Protects left hand from contact with the saw chain.	Adds slight weight. May snag in the brush.	Loss of protection.	May fail to protect if bent, loose, damaged or broken.	May provide less protection than original guard.
---	--	---------------------	--	--

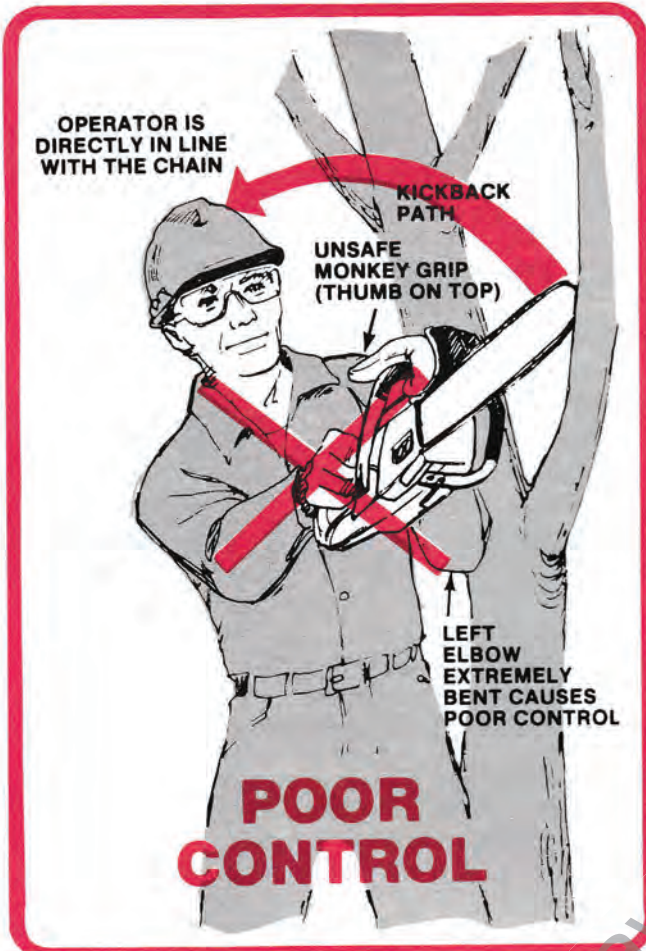

HOW TO MAINTAIN CONTROL

1. First of all, you must keep the front handlebar diameter in the webbing between the thumb and index finger of your left hand. This grip helps maintain control of the saw and limits the possibility that your hand will come in contact with the chain. See the illustrations of the correct and incorrect grips.

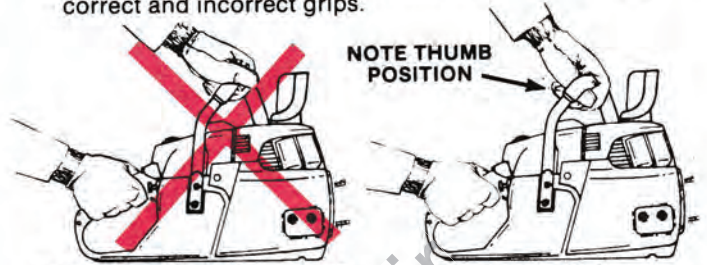

INCORRECT "MONKEY" GRIP

CORRECT GRIP

Do not use a "Monkey Grip" because your hand can slip.
Don't forget to wear your gloves.

2. Hold the front handlebar close to the balance point of the saw (or where you can best oppose and absorb the push, pull and kickback forces of the saw without having it twist out of your grip).
Do not reverse right and left hand positions on the saw handles.
3. Get a good grip on the rear handle.
4. Maintain your balance on both feet, and do not reach above chest height with the saw engine, or reach so far forward that you could be drawn off balance by the saw's reactions.
5. Stand a bit to one side so that no point of your body is behind the chain line (in the line the saw will take if it kicks back).

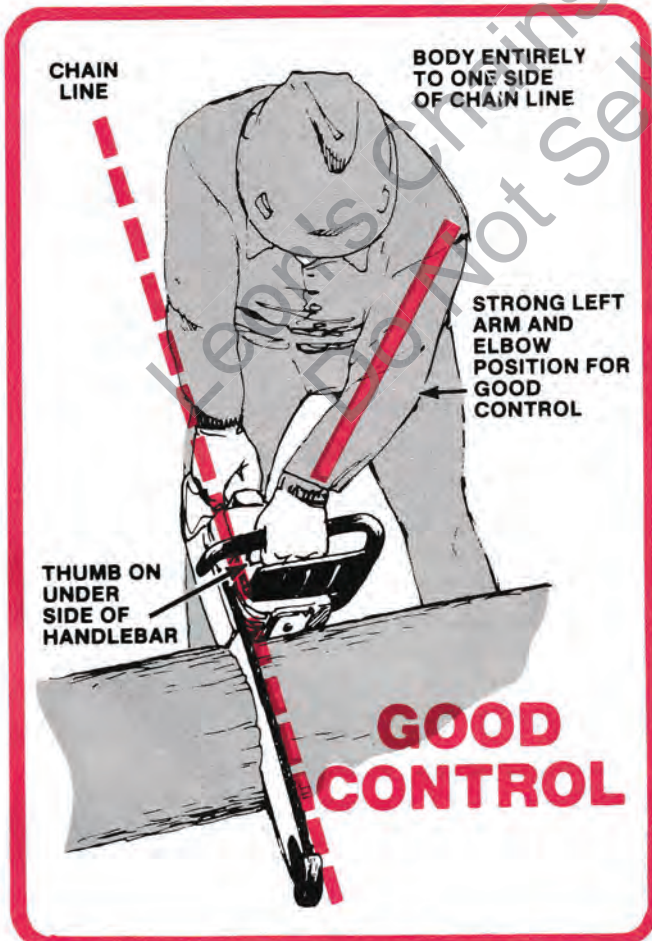

HOW TO REDUCE THE CHANCE OF KICKBACK

1. Avoid letting the nose section of the saw contact any object. Note: A SAFE•T•TIP® device, when properly installed on the bar nose, will prevent kickback.
2. Avoid use of the nose section of the saw for cutting. Cut well back on the straight section of the bar.
3. Be sure to keep your chain sharp and properly tensioned on the saw, because a loose or dull chain is apt to increase the chance of kickback.
4. Use extreme caution when cutting brush, hedges and other "whippy" material. Unless the saw has a properly installed SAFE•T•TIP device, cut only one piece at a time and make sure that the nose of the saw stays in the clear.
5. Never bore with the nose section of the saw unless you absolutely have to. If you really *must* make a boring cut with the nose, follow our instructions on page 17 for minimum risk of kickback.

SAFE•T•TIP DEVICE PREVENTS CONTACT WITH SOLID OBJECTS, PREVENTS KICKBACK WHEN PROPERLY INSTALLED



Without the anti-kickback device on your saw you would have to beware of these situations.

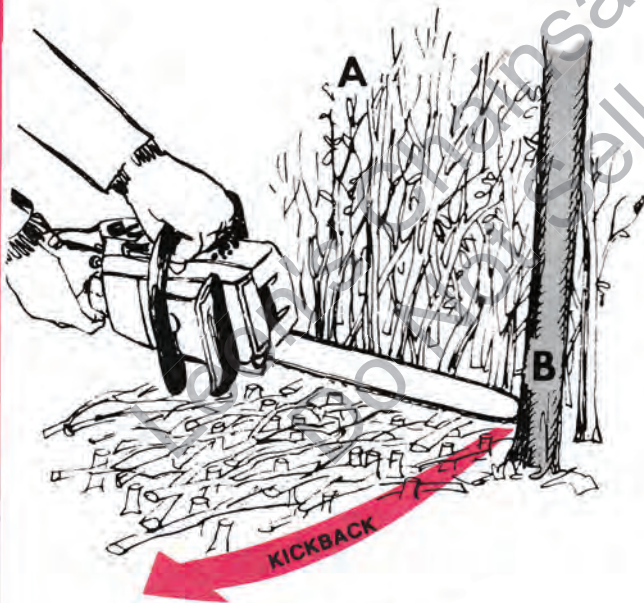
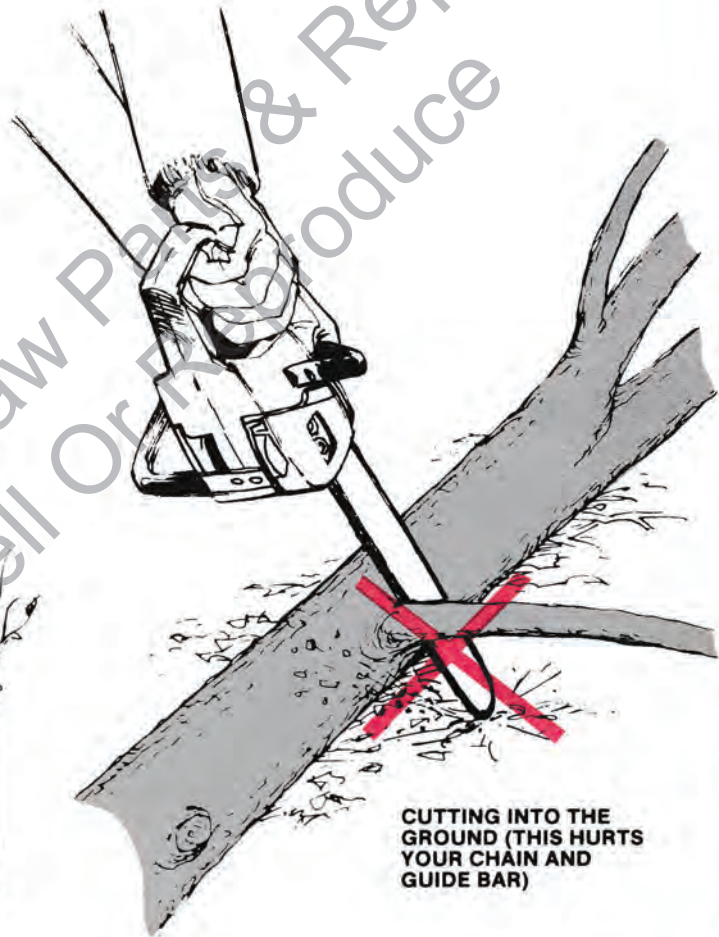
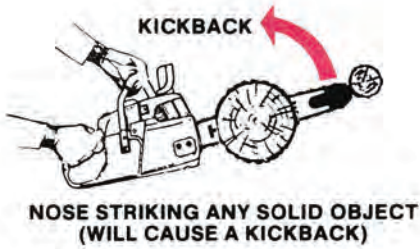
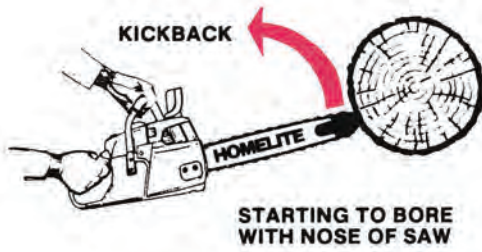

CUTTING MORE THAN ONE PIECE OF WOOD AT A TIME (NOTE THAT CUTTING BRUSH (A) CAN PULL THE SAW SO THAT THE BAR NOSE COULD CONTACT AN OBJECT SUCH AS TREE (B) RESULTING IN A SECONDARY REACTION — KICKBACK.)

HERE ARE SOME SITUATIONS WHERE THE SAFE•T•TIP® ANTI-KICKBACK DEVICE ACTUALLY MAKES CUTTING FASTER AND EASIER AS WELL AS SAFER.



DEVICE RESTED AGAINST AN OBSTRUCTION TO PREVENT CHAIN DAMAGE



CUTTING IN CLOSE QUARTERS SUCH AS NEAR MASONRY WALL WITHOUT HAZARD OF KICKBACK.



CUTTING ONE TRUNK ONLY OF A DOUBLE-TRUNK SHADE TREE



PLUNGING THE SAW BLADE INTO PILES OF BRUSH FOR QUICK CLEAN-UP.



USE A SCYTHING TECHNIQUE TO CLEAR LIGHT BRUSH

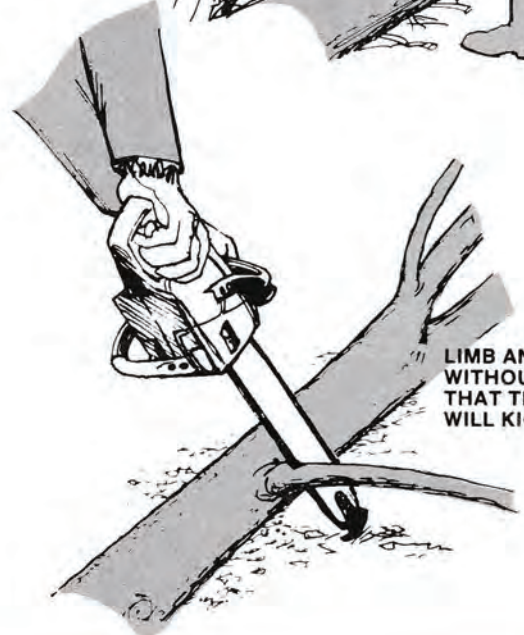

LIMB AND BUCK WITHOUT FEAR THAT THE SAW WILL KICKBACK

FACTS ABOUT THE CHAIN SAW

This Owner's Manual covers preparation, safe operation and maintenance. Be sure to read the Owner's Manual before preparing and using your saw.

This model has a 2.5 cubic inch, (40cc), 2-cycle gasoline engine which is vibration-isolated from the operator control handles by three isolators. The direct drive saw features an automatic oil pump, solid state ignition and third port fuel intake. The fuel is a mixture of 2-cycle type engine oil and either leaded or unleaded regular grade gasoline. The guide bar and chain can be lubricated with either a specially formulated bar and chain oil or any grade of clean motor oil. (See instructions for fuel and chain oil.)

VIBRATION ISOLATION

It has been reported that vibrations from hand-held tools (chain saws, pneumatic hammers, grinders, sledge hammers, etc.) may contribute to a condition called Raynaud's Syndrome in certain individuals. Symptoms may include tingling, numbness and blanching of the fingers, usually apparent upon exposure to cold. Hereditary factors, exposure to cold and dampness, diet, smoking and work practices are all thought to contribute to the development of these symptoms. It is presently unknown what, if any, vibrations or extent of exposure may contribute to the condition.

This saw is classified in the "semi-professional" category by many current regulations that differentiate between "professional" and "occasional use" saws. These varied regulations place limits on the amount of vibration which saws can transmit to the operator.

There are measures that can be taken by the operator to possibly reduce the effects of vibration:

- a) Keep your body warm in cold weather. When operating the unit, wear gloves to keep the hands and wrists warm. It is reported that cold weather is a major factor contributing to Raynaud's Syndrome.
- b) Refrain from smoking (another suspected contributing factor).
- c) After each period of operation, exercise to increase blood circulation.
- d) Take frequent work breaks. Limit the amount of exposure per day.
- e) Keep the tool well maintained, fasteners tightened and worn parts replaced.

If you experience any of the symptoms of this condition, immediately discontinue use and see your physician about these symptoms.

SAFE•T•TIP® ANTI-KICKBACK DEVICE

The Homelite® guide bar for your saw comes with the SAFE•T•TIP device properly installed on the bar nose. Be sure to check tightness of the mounting screw before each use (see page 9). When properly installed the SAFE•T•TIP device prevents chain saw kickback from happening.

HAND GUARD

Your saw has a hand guard designed to guard your left hand from the chain in the event you lose your grip on the saw.

CHAIN BRAKE

Homelite has supplied a SAFE•T•TIP® anti-kickback device with these saws. This is because a chain brake does not prevent kickback any more than a seat belt

prevents collision. A chain brake can only stop chain rotation.

For your safety, rely on the SAFE•T•TIP device to prevent kickback. And depend on using the proper grip and stance, and the safe cutting techniques recommended in this Owner's Manual to control the forces which tend to push or pull you and the saw during cutting.

At its best, a chain brake offers only partial protection against injury from kickback. In some situations it may be impossible for the brake mechanism to stop the chain before the saw blade reaches the operator. This is especially true in situations where the operator is positioned in close proximity to the saw blade.

A chain brake is not like a fire extinguisher which can be certified to work for a certain time. Too many things like breakage or wear, dirt, dust, sawdust, chain oil, and temperature changes in the chain saw's environment, can lengthen a chain brake's stopping time. The best chance you can give the brake to react effectively is to keep it clean. Even with daily cleaning of the mechanism, the dependability of a chain brake to perform under field conditions cannot be certified or even gauged. Keep the SAFE•T•TIP device on your saw's guide bar.

MUFFLER AND SPARK ARRESTOR

The large box type muffler reduces the exhaust noises to a noticeably lower range of sound. The front discharge exhaust outlet is covered by a replaceable spark arrestor screen and a baffled cover plate which directs the exhaust gases away from the operator. In states where spark arrestors are required by law, the owner/operator is required to keep it in good condition (intact) in the exhaust system at all times. Since the spark arrestor screen is of a fine mesh it is subject to clogging, cracking and burn out. A replacement screen should be kept on hand for maintenance.

ATTACHMENTS

This chain saw is designed for use with .325 pitch RAKER III® low-kickback saw chain, and guide bars from 16-inch to 20-inch cutting length. Do not adapt any guide bar or bow guide, or any other attachment or device to the saw powerhead unless such item is recommended specifically for this model by Homelite.

HEARING PROTECTORS

Long or continuous exposure to high noise levels, such as involved in the operation of a chain saw, may cause permanent hearing impairment or other possible effects. Hearing protection devices are available from your Homelite dealer or can be ordered through him. When ordering, specify "Homelite Hearing Protectors #92810."

YOUR PHYSICAL CONDITION

Work relaxed but stay alert and maintain control of your saw. Take a break from work whenever you begin to tire. Never operate when tired or under the influence of alcohol or any drugs which may affect your balance, alertness, or coordination or judgement. If you have any serious ailment such as a heart condition, check with your doctor before doing any strenuous lifting, reaching, pushing, chopping, shoveling, etc. Always do any lifting jobs with your leg muscles, not your back.

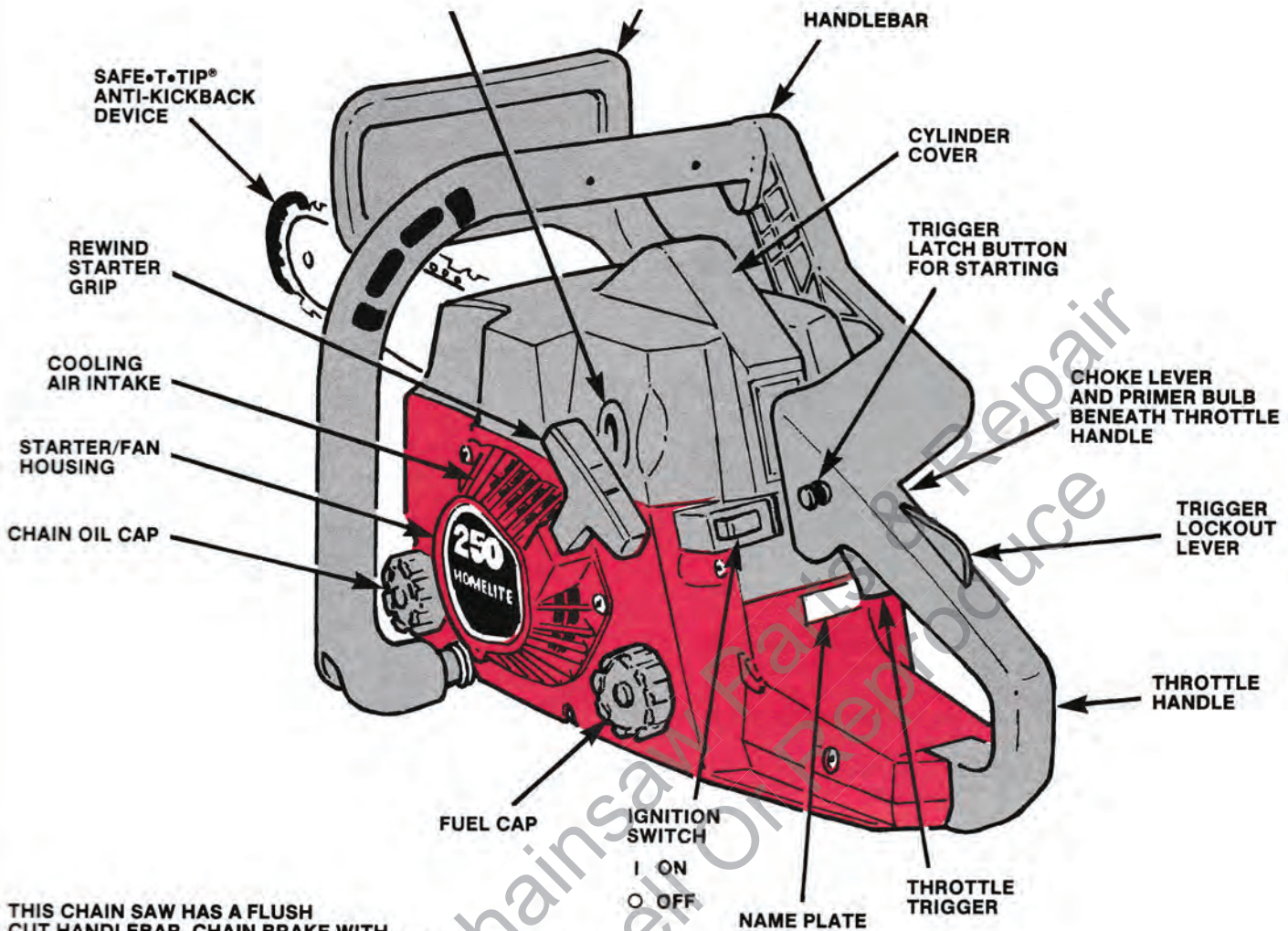

THIS CHAIN SAW HAS A FLUSH CUT HANDLEBAR, CHAIN BRAKE WITH BRAKE MECHANISM BUILT INTO DRIVE CASE COVER, AND THE HAND GUARD IS AN INTEGRAL PART OF THE CHAIN BRAKE.

PROTECTIVE ARTICLES, EQUIPMENT & SUPPLIES

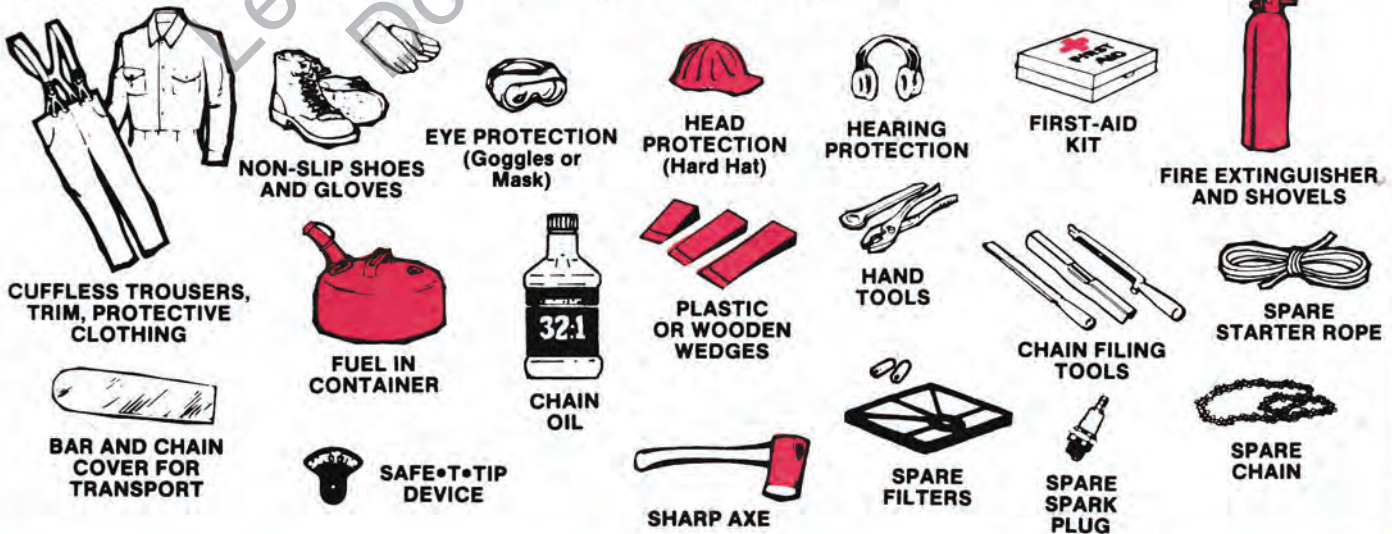

SECTION ONE - PREPARING FOR USE

CAUTION

Always wear gloves to protect your hands when working on the chain. And be sure the switch is in the (O) "OFF" position whenever you do any work on the saw.

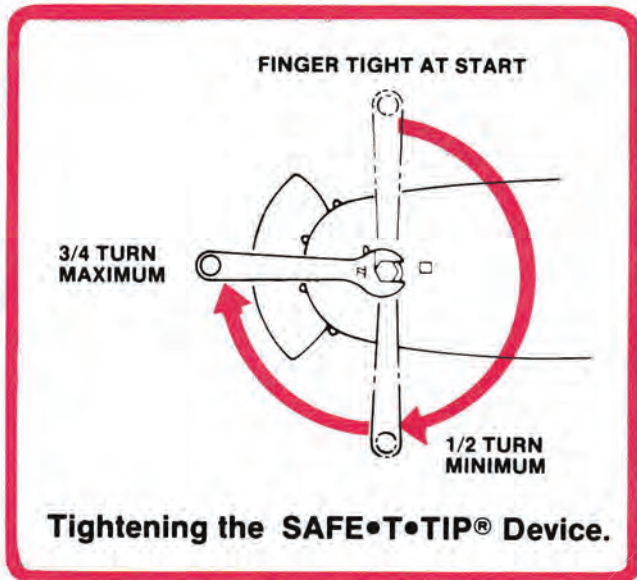

MOUNTING ANTI-KICKBACK DEVICE

IMPORTANT NOTICE

Before each period of operation, tighten the mounting screw of the SAFE•T•TIP® anti-kickback device as instructed below. This mounting screw is specially hardened. If it cannot be installed tightly, replace both the screw and the device before further use of the saw.

1. In addition to preventing chain contact with solid objects at the nose of the bar, the SAFE•T•TIP® device also helps keep the chain away from abrasive surfaces such as the ground. We recommend keeping the device on the right hand side of the bar, where it will be between the chain and the ground during FLUSH-WITH-THE-GROUND cutting.

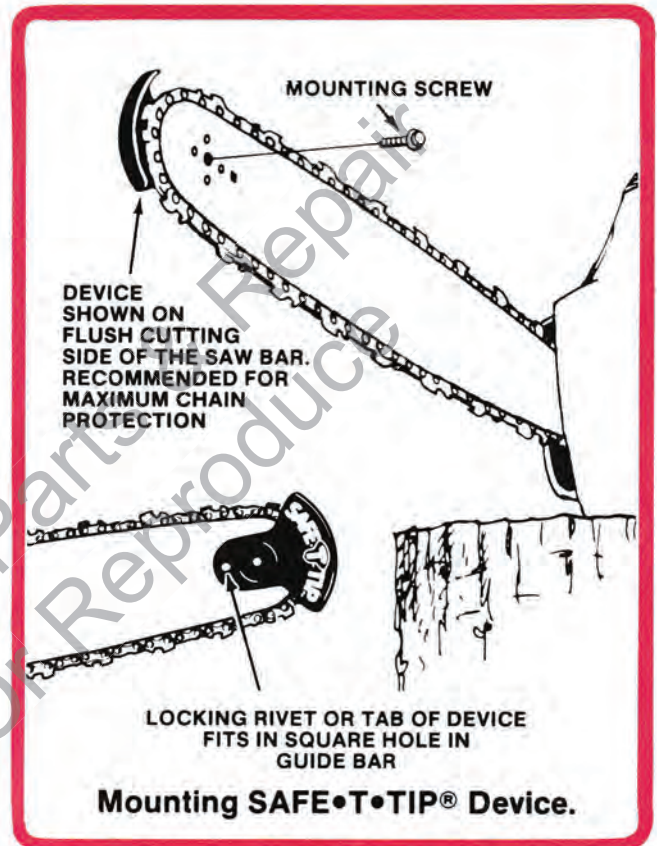

2. The device has a 1/4-20 x 5/8" mounting screw. It requires a 3/8" wrench (or adjustable wrench) to achieve the recommended tightness of 70 to 100 inch-pounds (8-11Nm). A tightness within this range can be achieved by the following method.
 - a) Mount the device on the bar nose (see illustration). Tighten the screw with your fingers.
 - b) From the finger-tight position, tighten the screw 1/2 turn to 3/4 turn more with a wrench.

BAR AND CHAIN ASSEMBLY

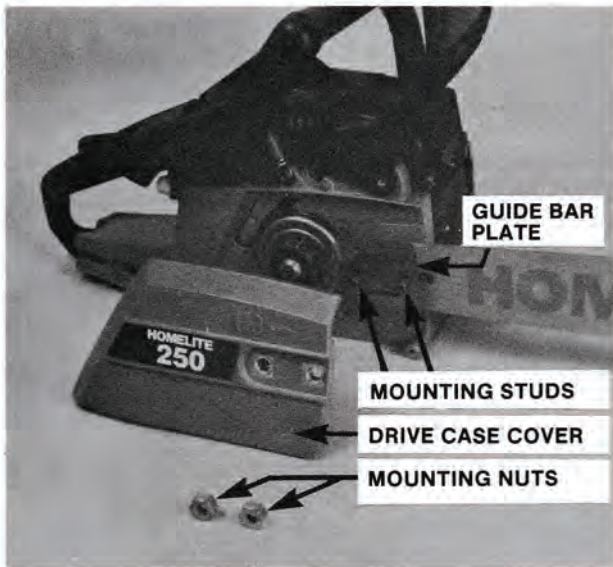

1. Pull the hand guard back towards the handlebar to disengage the chain brake.
2. Remove the two guide bar mounting nuts and loosen the captive screw at the top rear corner of the drive case cover.
3. The single guide bar shim is fastened to the guide bar pad and need not be removed.
4. Turn the guide bar adjusting screw counterclockwise to move adjusting pin to the rear of the slot.
5. Place the guide bar on the studs and engage the adjusting pin into the hole in the guide bar.
6. Lay the saw chain out in a loop. The cutters must have the sharp edges falling in the direction of rotation (see drawing). If they face in the wrong direction, flop the loop over and they will face correctly.
7. Pick up the loop and arrange one end over the clutch drum and around the chain drive sprocket.
8. Starting from the top of the sprocket, feed the chain drive links into the chain groove along top of the guide bar. Keep doing this until the chain goes into the groove around the nose of the bar.
9. Place the drive case cover onto the guide bar studs and loosely install the two guide bar nuts.

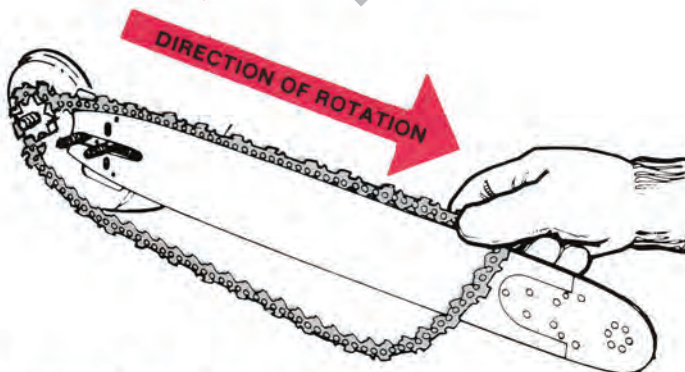

ARRANGE CHAIN AROUND SPROCKET AND FEED DRIVE TANGS INTO BAR GROOVE.

CAUTION

Always wear gloves to protect your hands when working on the chain. And be sure the switch is in the (O) "OFF" position whenever you do any work on the saw.

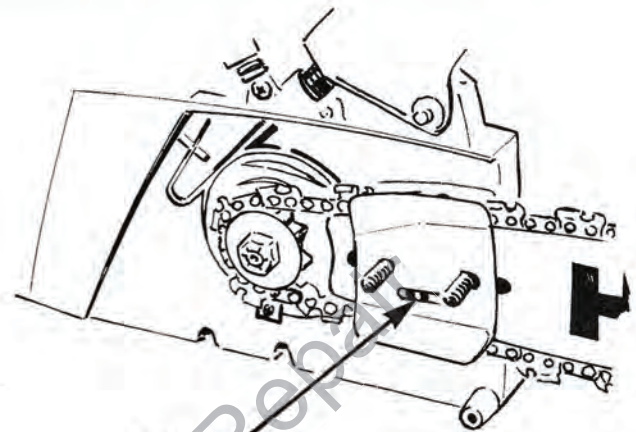

ADJUSTER PIN

LINE UP ADJUSTER PIN WITH HOLE IN GUIDE BAR

CHAIN TENSION

1. Mounting nuts should be finger-tight. Turn the adjuster screw clockwise to remove slack in the chain. Tighten until the chain tie-straps come up close to the bottom bar rails.
2. With your gloved hand "snap" the chain several times by pulling up and letting go of the chain. As this removes some of the stiffness, the chain may hang or droop from the bar.

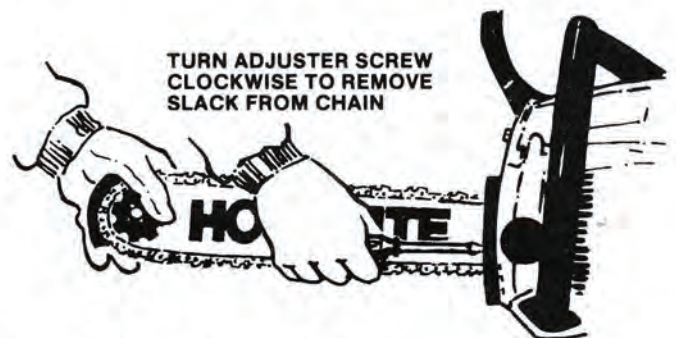

TURN ADJUSTER SCREW CLOCKWISE TO REMOVE SLACK FROM CHAIN

MOUNTING NUTS SHOULD BE ONLY FINGER TIGHT DURING TENSION ADJUSTMENT, THEN TIGHTENED FULLY AFTER TENSION IS SET.

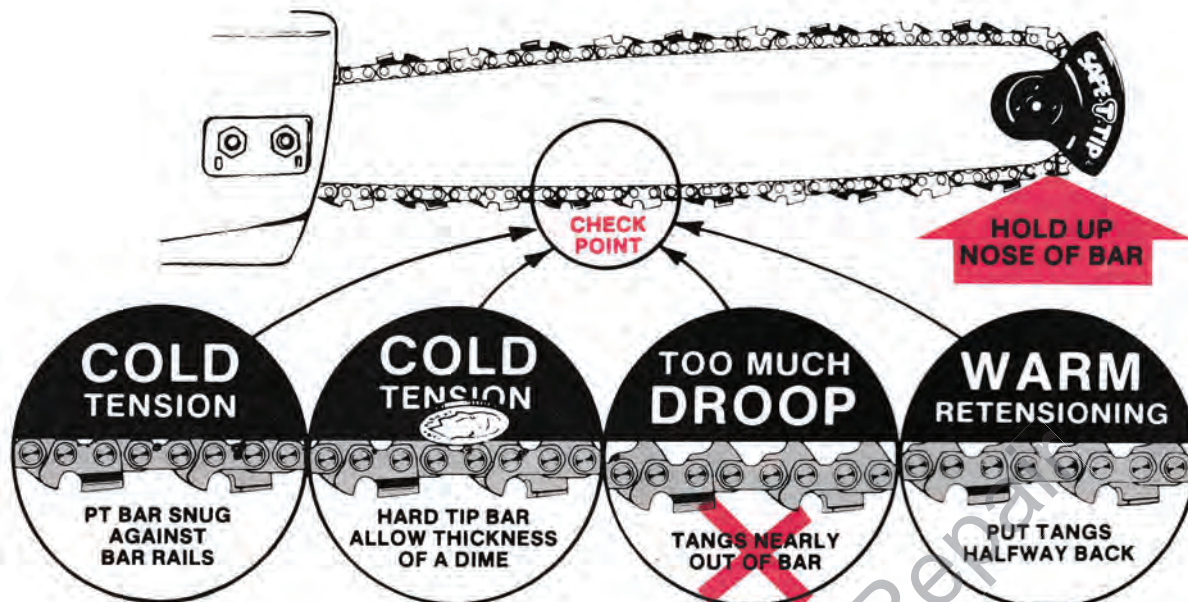

NOTE

From now on during the tensioning, hold up the nose of the bar until the mounting nuts have been tightened. This is to take up play between the bar slot and the mounting bolts.

AFTER WARM RETENSIONING ALWAYS RESET PROPER TENSION AFTER CHAIN HAS BECOME "COLD."

Steps 3 through 6 are for tensioning a cold bar and chain.

3. The proper tension is according to the type of the bar nose.
 - a) Sprocket nose (PT) bar: Increase tension until there is no clearance (zero droop) between the chain and bar. Pull chain along bar as you increase the tension. If you feel any binding, it is too tight.
4. While holding up the bar nose, tighten the nuts to lock the bar at proper tension.
5. Pull chain around bar by hand to check that assembly is correct. Start engine. Hold the saw free of obstructions and let the chain turn at slow speed for a few seconds. If droop develops, shut down the saw and reset the tension.
6. For the first few tankfuls of fuel, make light cuts only. Watch the tension. When the chain tangs hang more than halfway out of the bar, shut down and retension. New chain stretches rapidly due to the combination of limbering up, warming up, and friction wear of both the bar and chain surfaces.

Steps 7 and 8 are for retensioning a warm chain.

7. During operation, the chain will expand as it warms up. Once worn in, however, it will return almost to the original setting when it cools. Shut down immediately whenever the chain droops to where the tangs are hanging almost out or all the way out of the bar rails.
8. Warm chain should have the tension increased to where the tangs are drawn halfway into the bar groove. Hot chain cannot be tensioned accurately and should be allowed to cool.

CAUTION

After being tensioned while warm, chain may be too tight upon cooling. Check the "cold tension" before next use.

9. Tighten the mounting nuts when the tension has been set. Then you need not hold up the bar nose.

DAILY CARE OF BAR AND CHAIN

1. At the end of each day of operation remove the chain and guide bar. Clean the sawdust from the guide bar mounting pad, the clutch area and the drive case cover. Clean out the oil discharge hole in the guide bar mounting pad. Clean out the oil entry holes and the chain groove in the guide bar.
2. Sprocket nose guide bars must be lubricated while still warm from use, at the end of each day of cutting. Using the needle nose of Lube Gun #DA-52713B filled with HOMELITE® ALL-TEMP Multi-Purpose Grease, or our prepacked lube gun, pump grease into the sprocket nose bearing through the small grease hole in the side of the bar nose. Keep pumping until the dirty grease is forced out and fresh grease oozes out of the nose. This removes sawdust, dirt and moisture from the bearing. If bar is lubricated when cold, the old grease may not

come out. Sprocket nose bars in continuous use should be lubricated on-the-job every 1-1/2 to 2 hours. A sprocket nose bearing is good as long as it turns freely with no roughness or binding. However, it can be replaced with a new sprocket nose assembly whenever necessary.

BAR NOSE SHOULD STILL BE WARM WHEN NOSE IS LUBRICATED

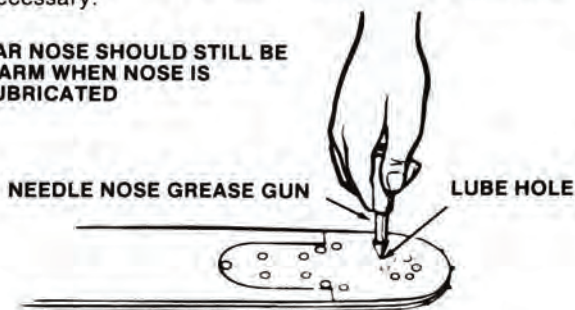

FILLING THE TANKS

1. Turn saw to the side so that the filler caps are on top.

CAUTION

Always loosen caps very slowly and wait for any pressure in the tanks to be relieved before you remove the caps.

2. Always fill the chain oil tank every time you add any fuel to the fuel tank. This will assure you that there is oil for the chain whenever you start and run the saw.
3. After filling the tanks, screw the caps back on tightly, and wipe up any spilled fluid.

CHAIN OIL

1. Our recommendation is to use **Homelite® Bar and Chain Oil** because it is designed expressly for bar and chain use without dilution throughout summer/winter climate conditions. Bar and Chain Oil is formulated with ingredients intended to minimize the problem of throw-off. Fill the oil tank right from the container. No mixing, no dilution necessary.
2. Any clean engine oil, including reprocessed oils, can be used as a chain oil. For warm climate conditions use an SAE-30 weight oil. In weather near or below freezing (0°C) where SAE-30 oil will thicken, either dilute it with enough kerosene (up to 25% as required) to restore its free-flowing property, or switch to a lighter oil such as SAE-20 or SAE-10.

BREAK IN PROCEDURE

To ensure long engine life and consistent high performance, it is very important that a careful break-in procedure be followed.

The first one gallon (4 liters) of fuel used in this engine should be mixed using twice the recommended amount of 2-cycle engine oil as directed on the container of either Homelite Premium Exact Mix or Homelite 32:1 Oil.

In addition, the high speed mixture adjustment should be set at a minimum of 1 1/4 turns open, or maximum "No Load" engine speed of 11,500 RPM, measured with bar and chain mounted and in operation during the break-in period. Avoid unnecessary high RPM "No Load" operation during this time. After the initial one gallon of fuel mixture has been consumed by the engine, the break-in period is considered complete.

FUELING (After Break-In)

This is a 2-cycle engine product and requires pre-mixing gasoline and 2-cycle oil.

WARNING

The fuel tank may be under pressure. Remove the cap slowly to avoid spurring of fuel.

CAUTION

Select bare ground for fueling. **DO NOT SMOKE** or bring any flame or sparks near fuel. Move at least 10 feet (3m) from the fueling spot before starting the engine.

1. Recommended Fuel:

- a) This engine will operate satisfactorily on any gasoline intended for automotive use. This includes gasolines blended with alcohols or ethers. If you are not satisfied with the performance of the product (running quality or startability) with these fuels, you may prefer to use unleaded gasoline that does not contain alcohol.
- b) We recommend the exclusive use of Homelite 2-cycle oils. Homelite 2-cycle engine oil, when mixed with gasoline according to the instructions on the oil package, will provide complete lubrication protection.
- c) All Homelite 2-cycle engine oils contain an anti-oxidant fuel stabilizer. Under average conditions, fuel mixed with Homelite oils will stay fresh up to 12 months.
- d) If Homelite oils are not used, we recommend stabilization of fuel with an anti-oxidant fuel stabilizer, such as STA-BIL, a product of Gold Eagle Co., Chicago, IL 60632. Unstabilized fuel will stay fresh for only up to three months and should not be used after that time.
- e) We urge you to use **Homelite 32:1 or Homelite Premium Exact Mix** oil for best performance and customer satisfaction. Oils formulated for air cooled 2-cycle engines at 40:1 or 50:1 ratios can be used at the Homelite specified 32:1 ratio (4 oz./gal.). Oils formulated at less than 32:1 ratio or non 2-cycle oils should not be used. They can cause smoking, oily residues, spark plug fouling, combustion chamber deposits, hard starting, etc.

2. Do Not Use Automotive Motor Oil.

3. How to Mix Fuel Thoroughly:

- a) Measure out the quantities of gasoline and oil to be used.
- b) Put some of the gasoline into the mixing can.
- c) Pour in all of the oil and agitate contents by stirring or shaking the can.
- d) Pour in the remainder of the gasoline. Again stir or agitate—this time for at least one minute.

HOW TO FUEL

WARNING

Loosen fuel cap slowly to allow safe release of pressure from the fuel tank.

1. Untwist and remove the fuel cap. Rest the cap on a clean surface so that it will not be a source of fuel contamination.
2. Pour in fuel carefully to the top. Avoid spillage by not overfilling.
3. Screw the fuel cap on tightly. Wipe up any fuel spillage immediately.

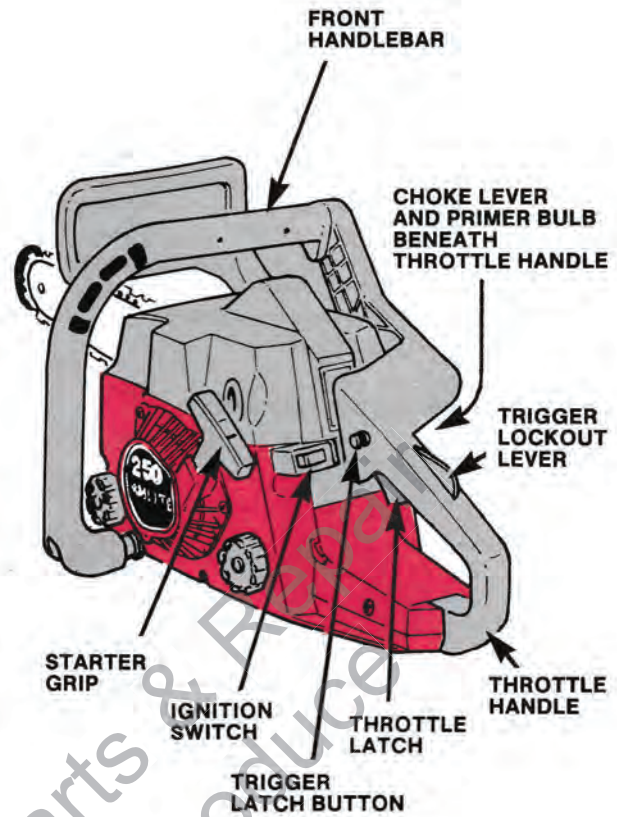
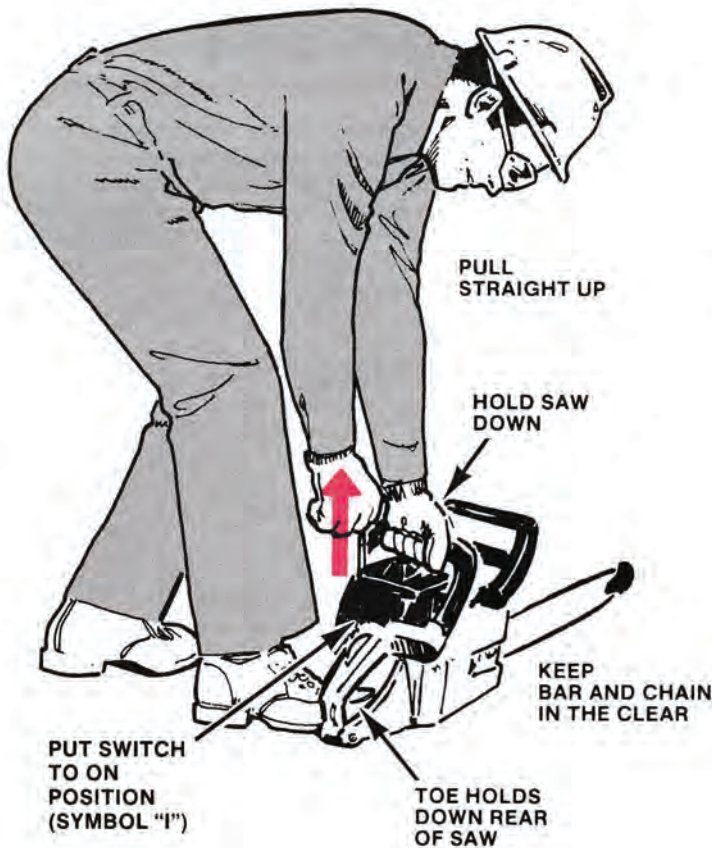

STARTING AND STOPPING

1. Set saw down on a clear, level spot where the saw chain will not be obstructed. Pre-lubricate the chain whenever chain is first mounted on the saw or remounted.
2. Push primer bulb until fuel is seen in bulb.
3. Move the switch to "I" ON position.
4. Pull choke lever outward.
5. Grasp throttle handle to depress trigger lockout lever and squeeze the trigger. (Note that trigger cannot be moved unless the trigger lockout lever is depressed.)
6. While squeezing the trigger, push and hold in the throttle latch button. And let go of the trigger first. This latches the trigger for starting.
7. Keep your body to the left of the saw. Hold the saw down with the left hand on top of the front handlebar. (Note: You can also place the toe of your footwear in the throttle handle platform to hold down the rear.)
8. Grasp the starter grip with your right hand. Pull the starter grip straight up to spin the engine rapidly. Use the following sequence for starting:
 - a) Crank repeatedly with full choke.
 - b) As soon as the engine coughs or fires a few times, push choke lever in.
 - c) Continue to crank engine until it starts.
9. Squeeze the trigger, this unlatches the throttle latch and gives you control of the throttle for cutting.
10. To stop, flick the switch to "O" OFF position with your thumb.
11. While the engine is still warm from recent operation, it can be started without the choke and without latching the throttle latch. When it has begun to cool, however, try starting with the trigger latched. If this does not work, crank to start at full choke.
12. Overcranking Remedy: The fuel system can flood and the spark plug can become "wet-fouled" if the unit was bumped and jostled during transport or if the saw was cranked a lot with the choke wrongly set. If you suspect this condition, do as follows:
 - a) Loosen the three captive screws and remove the cylinder cover to expose the spark plug.
 - b) Disconnect the spark plug boot from the plug and remove the plug.
 - c) Crank the engine three or four pulls at open choke and open throttle (by holding the trigger depressed with one hand). This purges the engine of excess fuel.
 - d) Install a dry spark plug (or use the old plug after wiping it clean and dry).
 - e) Reconnect ignition wire, install cylinder cover and follow starting instructions from paragraph 1 to start a (Cold) Engine.

TROUBLE-SHOOTING NOTE: Whenever the engine cannot be started you should refer to the detailed instructions in the Maintenance Section for filter cleaning, ignition spark testing, fuel system testing and carburetor adjustment.

SECTION TWO – THE WORKING AREA

WORK AREA PRECAUTIONS

Cut only wood or materials made from wood; no sheet metal, no plastics, no masonry, no non-wood building materials.

Do not allow children to operate your saw, EVER. Allow no person to use this chain saw *who has not read this Owner's Manual* or received adequate instructions for the safe and proper use of this chain saw.

KEEP BYSTANDERS A SAFE DISTANCE FROM THE CUTTING AREA



Everyone—helpers, bystanders, children and animals, and other operators—must be kept a safe distance from the cutting area. During felling operations, the safe distance should be at least twice the height of the largest trees in the felling area. During bucking operations, space buckers and limbers adequately so they cannot interfere with each other. Only one person should be working on a tree.

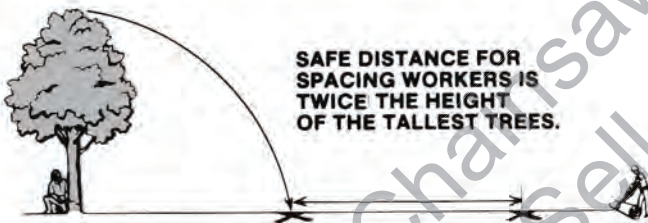

SAFE DISTANCE FOR SPACING WORKERS IS TWICE THE HEIGHT OF THE TALLEST TREES.



WEDGE IS USED TO HOLD CUT OPEN

STAND ON UPHILL SIDE WHEN CUTTING BECAUSE LOG MAY ROLL.

During bucking operations always cut from the uphill side so that the cut-off section of the log will not roll over you. You can be pulled off balance if you have your weight all on one leg, so be sure to stand with both feet on solid ground. Make sure that cut-off wood will not fall on your toes or on your head. Do not cut straight overhead for this



OPERATOR HAS POOR CONTROL OF SAW IF HE OVERREACHES OR CUTS ABOVE CHEST HEIGHT.

WHEN LIMBING, STANDING WITH THE LOG BETWEEN YOU AND THE WORK OFFERS MAXIMUM SAFETY.

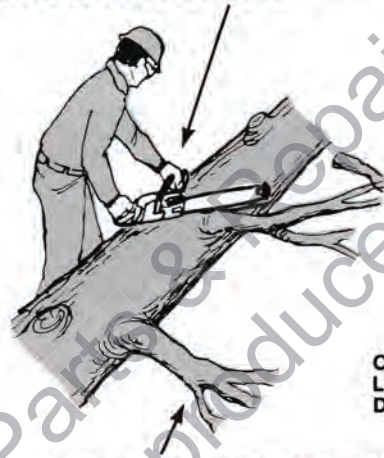

LEAVE SOME SUPPORTING BRANCHES UNCUT. AFTER YOU HAVE BUCKED UP THE LOG SECTIONS YOU CAN CUT OFF THESE LAST FEW LIMBS.

In areas near roadways or power lines, do not operate until you have permission from the authorities. When working near roads, you must post flagmen to control traffic. If you accidentally knock down a power line or discover one that is down, **DO NOT GO NEAR IT**, but notify the power company as soon as you are able. A downed power line is a good illustration of why woodmen should pair up and always keep within calling distance of one another. In the event of trouble such as this, one man can stand guard while the other summons help.



DON'T GO NEAR DOWNED POWER LINES. SEND SOMEONE TO NOTIFY THE POWER COMPANY. STAND BY TO WARN OTHERS TO KEEP CLEAR.



CUTTING ALOFT OR FROM LADDERS IS EXTREMELY DANGEROUS.

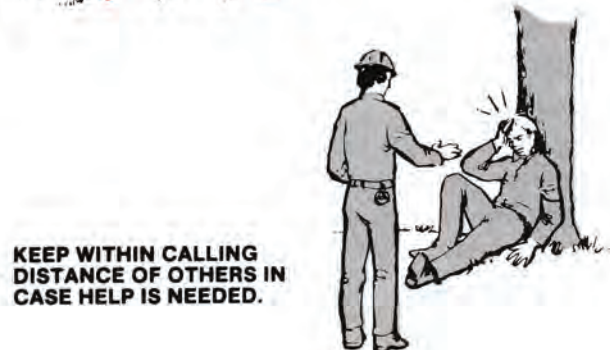

KEEP WITHIN CALLING DISTANCE OF OTHERS IN CASE HELP IS NEEDED.

When the diameter of the wood is large enough for a wedge to be inserted in the cut behind the saw chain, use a wedge to hold the cut open when there is a danger of pinching the saw blade. When felling large trees, wedges should also be used to control the fall. Never use hard metal wedges which could damage the saw chain.

Clear your working area of all materials likely to trip you, snag the saw, catch fire from the hot exhaust, or block your safe retreat from a falling tree.

Before cutting limbs or felling trees, inspect the area to be sure the wood will not strike buried pipelines or damage property.

HANDLING AND SECURING THE SAW

ALL EQUIPMENT MUST BE SECURED IN VEHICLES WITH STRAPPING OR TIE-DOWNS. PERSONNEL SHOULD NOT BE TRANSPORTED IN THE SAME COMPARTMENT AS EQUIPMENT AND FUEL SUPPLIES.



Inspect your saw every day before use. Keep the fuel cap, oil cap and air filter cover on tightly. Check condition of the fuel line, spark plug and spark plug wire. **DO NOT OPERATE IF THE ENGINE BACKFIRES OR THE SAW LEAKS FUEL.** Have your saw serviced by an authorized serviceman. Be sure to keep your saw chain in proper condition on the saw. Remember that a dull or loose chain snags more easily than a sharp, snug chain. Touch up the chain after two hours of steady cutting and sharpen it thoroughly after 8-10 hours of use. (See Chain and Bar Maintenance in Section 4.) If chain is damaged by abrasives or hits a stone or nail, put on a spare chain immediately and have the damaged chain repaired and sharpened.

If there is anything wrong with the saw have it fixed before further operation. The idle speed adjustment should be maintained so that the chain stops moving after the engine is brought back to idle. Adjust the idle speed whenever necessary (see Section 4).

NOTE

Do not disassemble the rotor (flywheel). Special techniques are required (on a dealer level) for safe removal and installation of the rotor.

Always use a muffler on your saw and keep it in good repair. A faulty muffler (or open exhaust) can cause hearing damage and also a fire hazard. Your saw comes equipped with a spark arrestor. Be sure to use it on your saw. In some states a spark arrestor is required by law and it is the operator's legal responsibility to see that it is on the saw and in good working condition. Check the muffler and spark arrestor at regular intervals. Careful! Never touch a hot muffler.

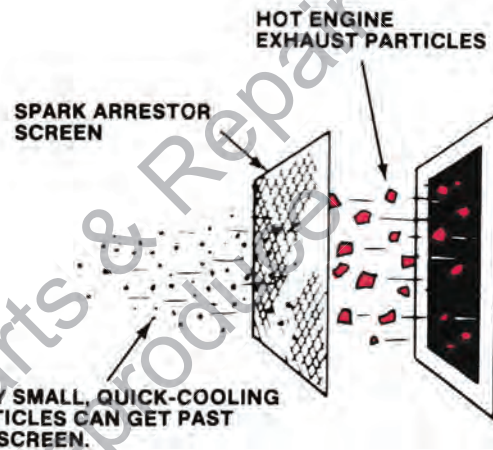

UNUSUALLY HAZARDOUS CONDITIONS

Do not fell trees or go underneath them during periods of high wind or heavy precipitation. Take no chances during periods of extreme hazard. You can wait to do your cutting after the hazard has ended.

Do not use saws to cut down trees having an extreme lean or large trees that have rotten limbs, loose bark, or hollow trunks. Have these trees pushed or dragged down with power equipment. Then you can cut them up.

Work only when visibility and light are adequate for you to see perfectly what you are doing.

SECTION THREE - TECHNIQUES OF CUTTING

When you are going to cut wood — DO IT RIGHT!

BUCKING, LIMBING AND PRUNING TECHNIQUES

For your first cutting experience, set up a small log so that one end is off the ground. Practice your overbucking technique by cutting firewood length sections off the raised end. (See illustration.)

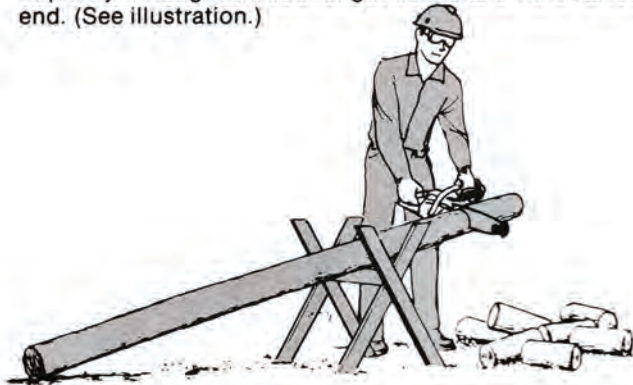

1. Position yourself and the saw for cutting. Hold the saw near the log and throttle up to full speed just before letting the chain touch the wood. Then exert moderate feed pressure to help the chain cut the wood. The chain must always be running at full throttle speed when it is contacting the wood, or you will burn out the clutch.
2. If desired you can pivot the saw blade back and forth during cutting. This often helps to speed up the cutting a bit.

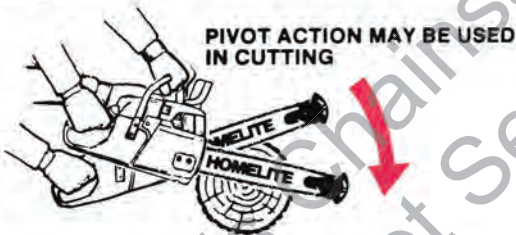

3. You will notice a slight amount of *pull* reaction during cutting. So be ready for the moment the saw breaks through the wood and *pull* ceases. You must be ready to stop pushing down on the saw and hold the saw nose up. The moment the chain breaks clear, release the throttle trigger so the engine will not overspeed.

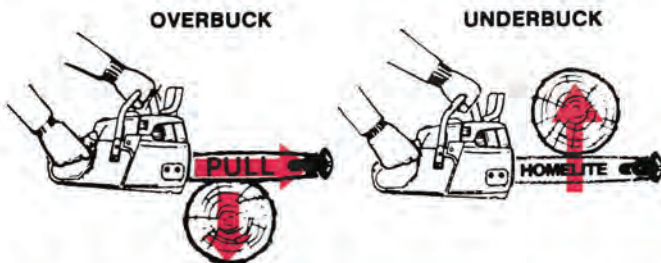

4. When you have mastered the overbucking technique, try underbucking to see what it feels like. Place the saw blade under the log. Throttle up and exert upward pressure to cut clear through. Now you are ready to learn when to overbuck and when to underbuck in order to avoid pinching the chain in the wood.

CUTTING VARIATIONS ACCORDING TO THE STRESS FACTORS

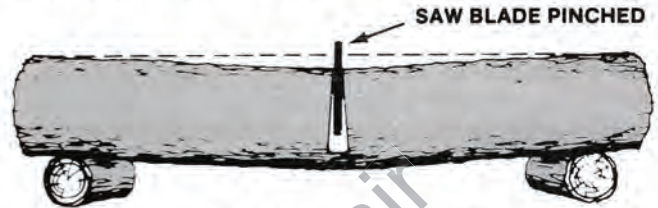

When the piece to be cut is supported on the ends, but not along the point where you want to cut, it will bend as you make your cut. If you are overbucking a log that will bend downward at the cut, your saw will be pinched if you cut more than 1/3 the log diameter. So overbuck 1/3, then remove the saw and finish with an underbucking cut from the bottom of the log. This 1/3-2/3 cutting technique helps to avoid pinching of the saw and splitting of wood that is under stress. With small diameter wood, you can make the whole cut by underbucking as long as you don't care if the wood splits. The reverse of the above is true when the log will bend upward at the cut. In this case, underbuck 1/3 through, and then overbuck so that the cut will open up instead of closing on the saw blade.

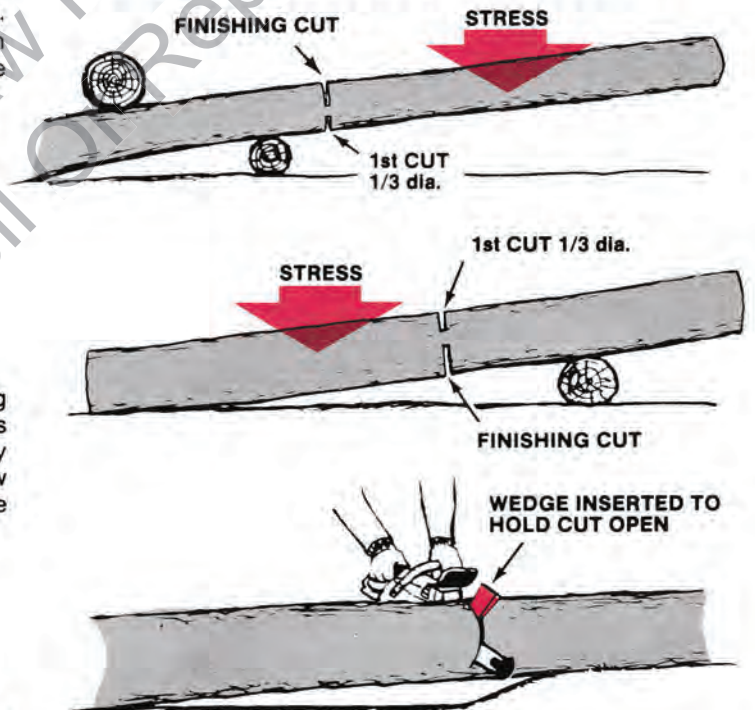

Sometimes it is impossible to avoid pinching (with just standard cutting techniques) or difficult to predict which way a log will bend when cut. You can do this to prevent pinching: If the wood diameter is large enough for you to insert a soft bucking wedge without touching the chain you should use the wedge to hold the cut open. Sometimes a pocket in the ground will allow the cut section of log to settle, resulting in a pinch. The wedge is also useful here, but in this case you can cut on a slight angle (as illustrated) so that any settling of the log will result in increasing the gap between the cut log sections.

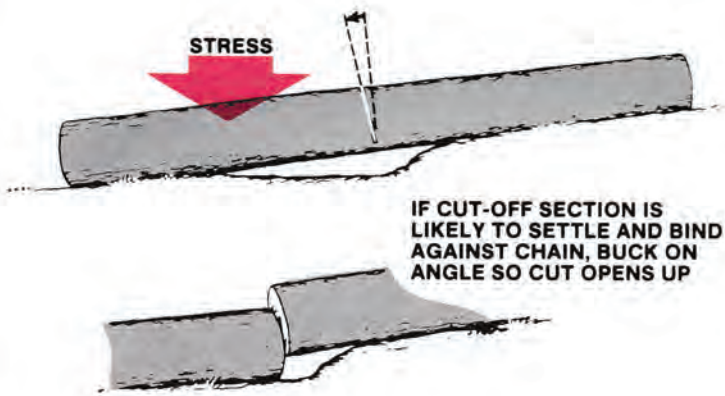

IF CUT-OFF SECTION IS LIKELY TO SETTLE AND BIND AGAINST CHAIN, BUCK ON ANGLE SO CUT OPENS UP

When pruning shade trees it is important not to make the flush cut next to the main limb or trunk until you have lopped off the limb further out to reduce the weight. This prevents stripping the bark from the main member. Unless the branch to be pruned is supported by another branch, the stress will be downward (see illustration). Underbuck the branch 1/3 through, then overbuck to drop the branch off. Now make your finishing cut smoothly and neatly against the main member so the bark will grow back to seal the wound.

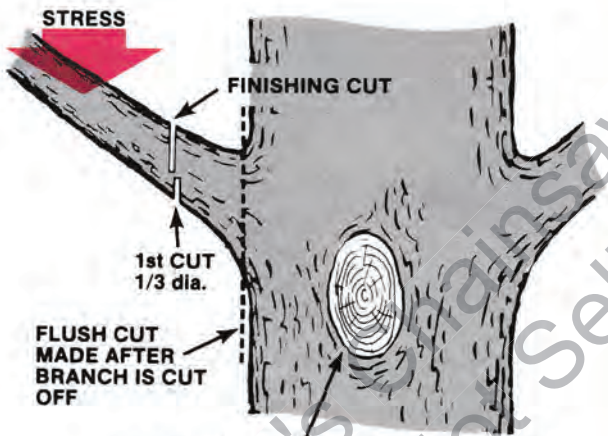

WHEN BRANCHES ARE TRIMMED NEATLY FLUSH WITH THE TRUNK, THE BARK CAN GROW BACK TO SEAL THE WOUND.

SPRINGPOLES

A springpole is any log or branch or sapling which is bent under tension by other wood so that it will spring back if the wood holding it is cut or removed. Watch out for springpoles. They are potentially dangerous.



THIS IS A SPRINGPOLE BENT DOWN UNDER HIGH STRESS

BORING WITH THE NOSE SECTION

KICKBACK DANGER

There is a great possibility that the saw will kickback during the start of the boring cut.

Boring should be attempted only by experienced operators because it requires extreme care and attention to proper technique. Do not bore unless there is no other way to make a cut. Boring is usually resorted to in order to avoid an obstacle or when it is necessary to make blind holes such as cut-outs for log cabin windows. The SAFE•T•TIP® anti-kickback device must be removed for a boring cut. Boring increases the chance of kickback and also wears the chain and bar at an accelerated rate. Although it may not prevent kickback from happening, the Raker III® chain on your saw may help you to keep control by reducing the force of a kickback reaction.

Study the panel illustrating a boring operation. As shown, the danger will be minimized if you can make first contact on the underside of the bar as far back from the bar nose as you can get. Then cut downward into the wood until the tip is buried in the cut. Gradually bring the saw level, then bore through the wood to full length of the blade. Now you can cut either upward or downward through the wood as shown in the panel.

BORING TECHNIQUE

- 1** MAKE FIRST CONTACT ON LOWER QUADRANT

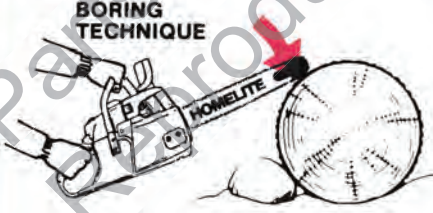
- 2** CUT DOWNWARD TO BURY NOSE OF SAW IN THE WOOD AND ALIGN SAW FOR THE BORE

- 3** GRADUALLY SHIFT PRESSURE FORWARD TO BORE STRAIGHT IN

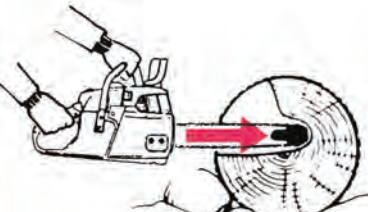
- 4** CUT UPWARD OR DOWNWARD AS REQUIRED

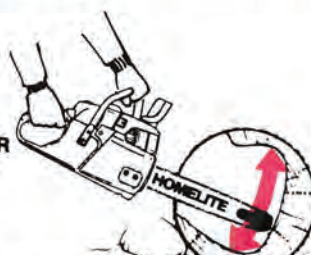

REPLACE THE SAFE•T•TIP® ANTI-KICKBACK DEVICE TO PREVENT INJURY DUE TO KICKBACK

TREE FELLING TECHNIQUES

CAUTION

If the saw gets caught or hung up in a tree during felling, leave the saw and save yourself. The saw can be replaced and you cannot!

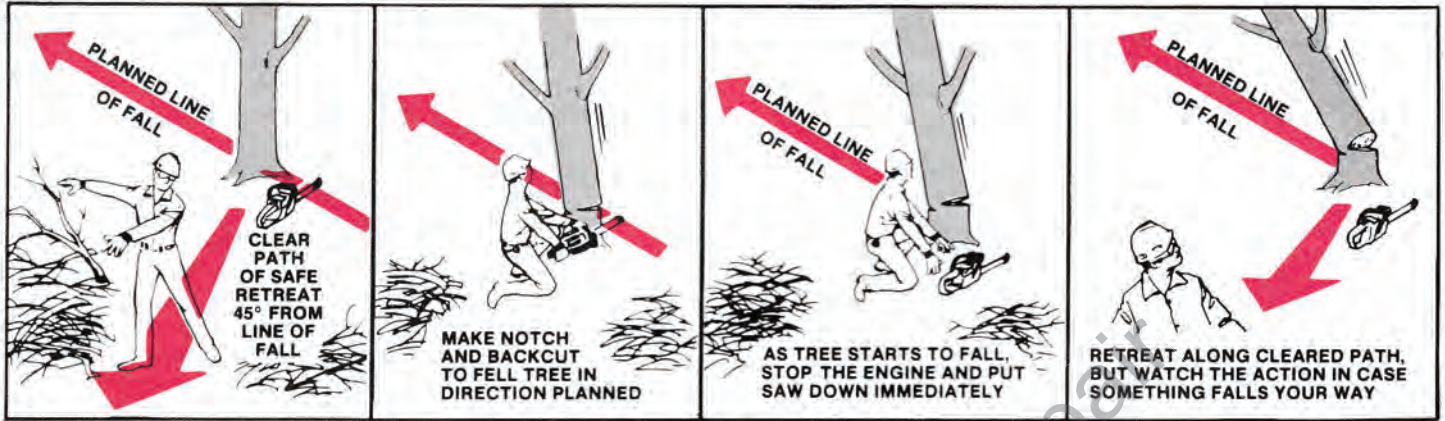

1. Pick your escape route (or routes in case the intended route is blocked). Clean the immediate area around the tree, and make sure there are no obstructions in your planned path of retreat.
2. Consider the factors of wind direction and velocity, the natural lean and the balance of the tree, and the location of large limbs. These things influence the direction in which the tree will fall. Do not try to fell a tree along a line different from its natural line of fall until you have had considerable experience in felling trees which present no problem as to where they will fall.
3. Take into consideration whether the trunk is sound or so rotted inside as to snap and crash while being cut. Also look for broken or dead branches (widow makers) AND don't go below any widow makers.
4. In tight situations where a mistake in the direction of fall could ruin other trees or destroy property, attach a tether line to the tree as illustrated.
5. If the tree is not badly out of balance, cut a notch about 1/3 the diameter of the trunk. This notch whether standard or "Humboldt" is made in the side the tree is to fall. And the cuts of the notch are made so they intersect at a right angle to the line of fall. This notch should be cleaned out to leave a straight line. To keep the weight of the wood off the saw always make the lower cut of the notch before the upper cut. We illustrate a common notch made with a horizontal cut and an angular cut above it. A "Humboldt" notch, with the horizontal notch on top, is made when trees are to be cut for saw log processing.

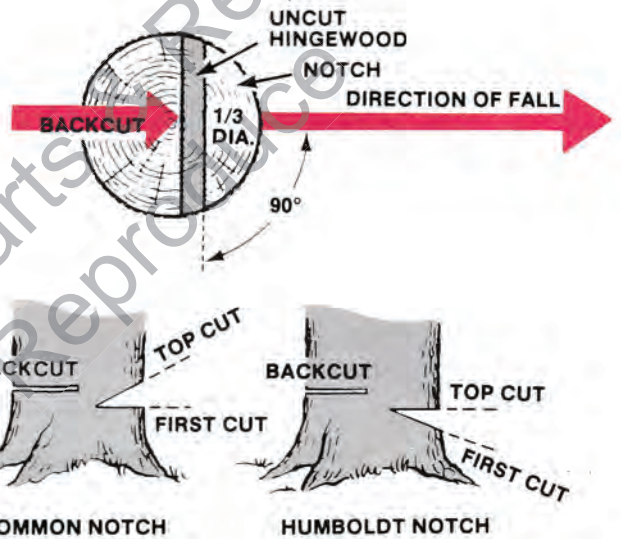

6. The backcut is always made level and horizontal and at a minimum of 2 inches (51 mm) above the horizontal cut of the notch. As a guide to placing the backcut above the notch, figure 10% of the face diameter as the proper height. Be very careful to make a level backcut. As a slanted back cut can cause the tree to split or "barber chair" (see illustration).
7. You must never cut through to the notch. Always leave a band of wood uncut between the notch and back cut.

HELPING TREE TO FALL IN DIRECTION PLANNED



MAKE BACKCUT 2" OR MORE ABOVE HORIZONTAL CUT OF NOTCH

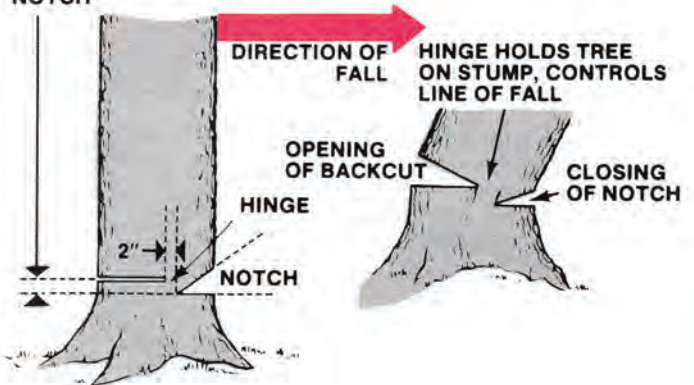

This is called "Hinge" or "Hingewood." It controls the fall of the tree and prevents slipping or twisting or shoot-back of the tree off the stump. If the tree starts over in the wrong direction, or if the saw gets caught or hung up during the fall, leave the saw and save yourself!

- On large diameter trees, it is proper to stop the backcut before it is deep enough for the tree to either fall or settle back on the stump. Then, soft wooden or plastic wedges (not hard metal) are inserted behind the saw so they do not touch the chain. The wedges can be driven in, little by little, to help jack the tree over.



WEDGE IS USED TO HOLD CUT OPEN

- Trees larger than the saw can cut in one cut, can be both notched and backcut in a series of cuts, as illustrated. Start the notching cuts from one side and draw the saw through to the other side of the notch. Start the backcut on one side of the tree, pivoting the saw through to form the desired hinge on that side. Then remove and reverse the saw for the second cut. Insert the saw in the first cut, very carefully so as not to cause kickback, and cut back toward and around the back of the trunk. Complete the backcut by cutting towards the notch to complete the hinge section.

NOTE

Insert your felling wedges in the backcut. Remove the saw before tree is ready to fall and drive the wedges in to fell the tree.

NORMAL SEQUENCE USED TO FELL VERY LARGE TREES (UP TO TWICE BAR LENGTH IN DIAMETER)

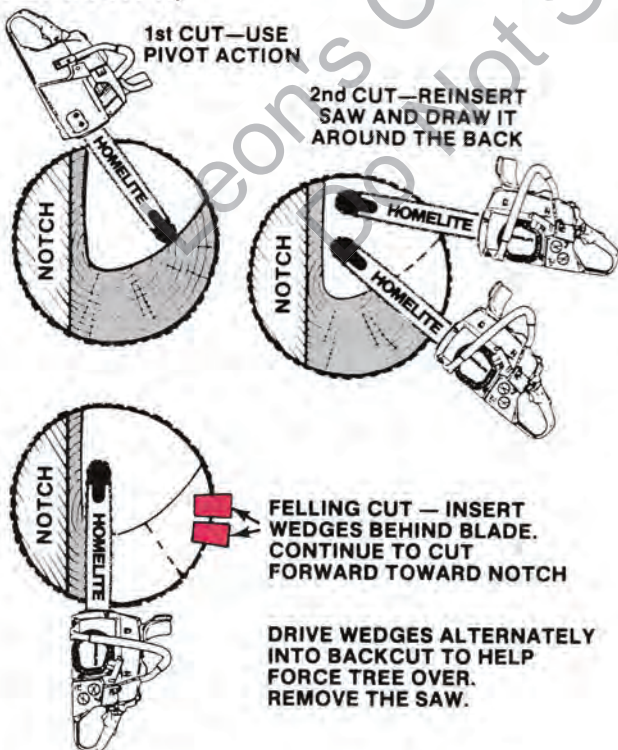

FELLING LEANERS

This variation is designed to prevent splitting and "barber chair" of leaners. All standard felling techniques apply to leaning tree except as follows:

- Make the directional control face notch shallower than usual.
- Make shallow notches on both sides of the tree to cut through the outer layer (sapwood).
- Now make your backcut to leave a parallel hinge.

WHEN CUTTING LEANERS, AVOID SPLITTING AND BARBER CHAIR BY MAKING THE FACE NOTCH (1) AS DEEP AS IS SAFE. THEN MAKE SIDE NOTCHES (2 AND 3) TO CUT THROUGH THE SAPWOOD BEFORE STARTING THE BACKCUT (4).

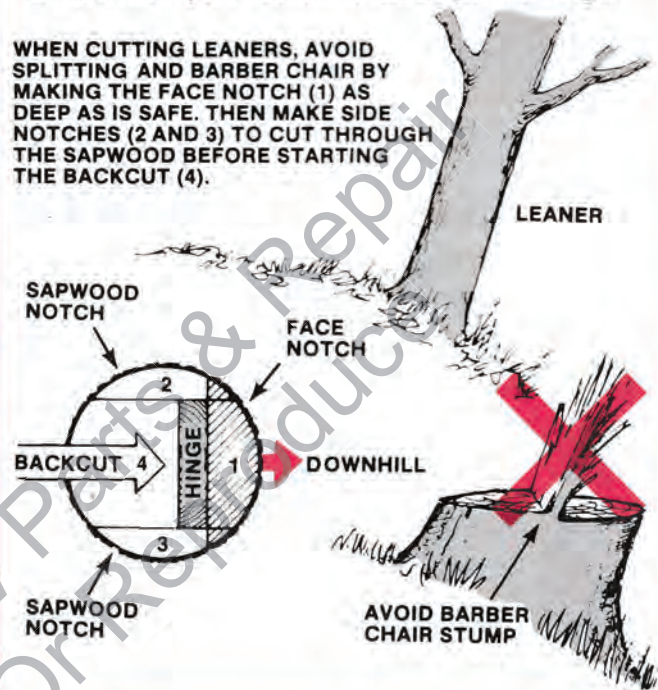

CHANGING THE DIRECTION OF FALL (from the natural line of fall)

- Where you would leave a parallel hinge (hingewood of equal thickness on both sides) the hinge is left thicker on the side toward which you want the tree to switch (away from the natural line of fall). The thicker hinge on that side will hold up the fall so that the tree will fall to that side.
- Place your wedges in the backcut between the back-center and the narrow side of the hinge. Drive in the wedges to force the tree over in the direction desired.

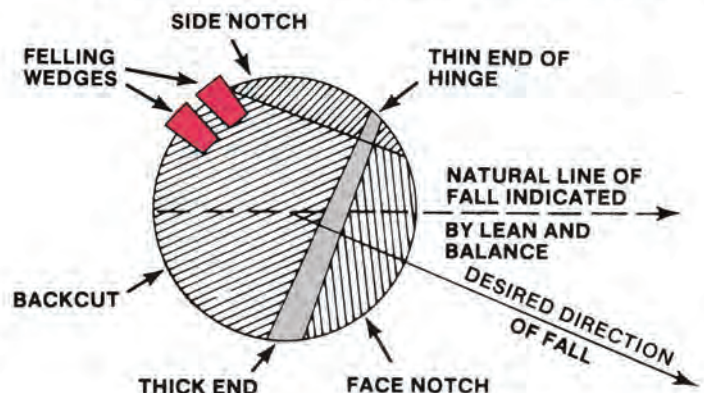

SECTION FOUR

MAINTENANCE AND REPAIR

HOMELITE® RAKER III® SAW CHAIN

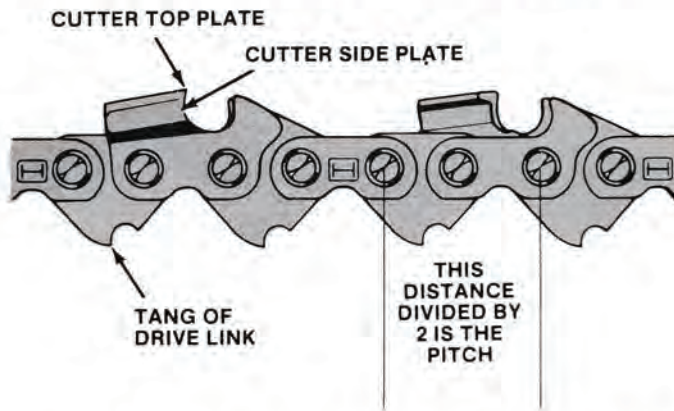

Low-kickback type 32-LE50 chisel tooth, .325 pitch, Raker III saw chain has three rakers (depth gauges) instead of just one gauge preceding each tooth. When chain contact is made within the kickback zone of a guide bar nose, the three rakers provide sufficient support to prevent the cutters from pulling themselves deeply into the wood. Thus the tendency toward a violent kickback reaction is suppressed or reduced.

For smooth and fast cutting, RAKER III chain needs to be maintained properly. Shut down the saw for filing whenever the sawdust turns from chips to a fine powder and you have to bear down hard to make the saw cut. Follow our instructions for filing the cutters and maintaining the rakers at proper depth.

TOOLS FOR SHARPENING RAKER III TYPE 32-LE50 CHAIN

Our file holder (#A-92611) comes with a 3/16" diameter (4.8 mm) round file. This file holder has 30° guide marks. The 30° marks should be used when filing RAKER III chain.

After repeated sharpenings, when the teeth are reduced to a bit less than half their original length, use a 5/32" diameter (4.0 mm) file. The smaller diameter file is necessary because the teeth taper to a lower height towards the rear.

HOW TO FILE THE CUTTERS

If you do not have a chain filing vise, you can do a satisfactory job "on the bar" if you tighten the chain tension enough that the chain doesn't wobble. And, do all of your filing at the mid-point of the bar. Wear gloves for protection. Be sure to file all cutters to the same length. This must be done because of the taper of the teeth; if some cutters are shorter than others only the longer cutters will get a chance to cut. Also be careful to file all cutters to the specified angles, as fast cutting can be obtained only when all cutters are uniform. Each cutter then gets a chance to cut.

1. Any top plate filing angle from 30° to 35° will work well as long as every cutter is filed to the selected angle. However, the angle recommended for best results is 30°.

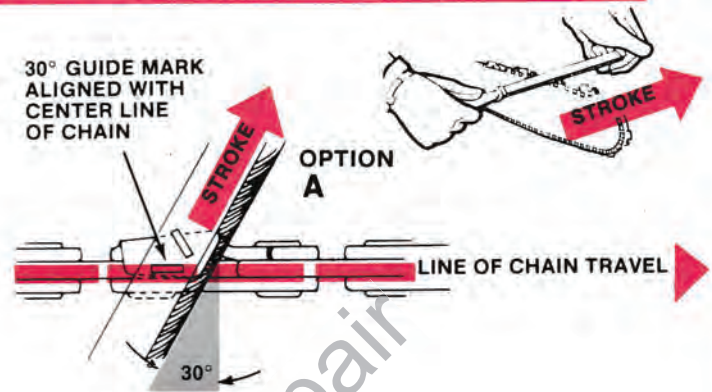

2. Keep the file level with the top plate of the tooth. Do not let the file dip or rock.
3. Stroke only towards the front corner of the tooth. Lift file away from the steel on each return stroke.
4. Use light but firm pressure — mostly towards back of tooth and very little downward. With the correct angle and pressure maintained by you, the file holder will produce the desired edge.
5. Put a few firm strokes on every tooth. File all left hand cutters on one side. Then move to the other side and file the right hand cutters. Occasionally rotate the file in the holder.
6. Check your filing job in strong light. A sharp edge does not reflect light. Put a few more strokes on edges which reflect light.
7. If you are not satisfied with the performance of your chain after it has been filed, examine it for "skid-nose" and one or more of the common chain faults illustrated in this section. Also be sure to check the depth of the rakers frequently as instructed under "Raker Clearance."

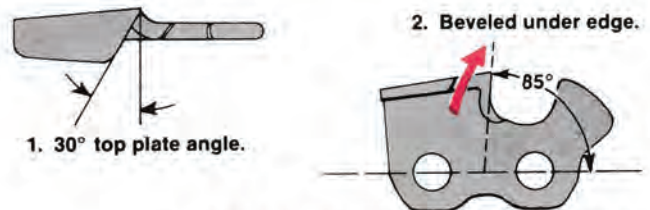

REPAIR NOTE

Raker III chain construction is shown in exploded view form. Should replacement of damaged cutters be required we recommend using pre-set tie-straps in place of left-hand cutters. Because putting a few new cutters into an old chain loop can render the chain kickback-prone, we no longer include cutters in chain repair kits.

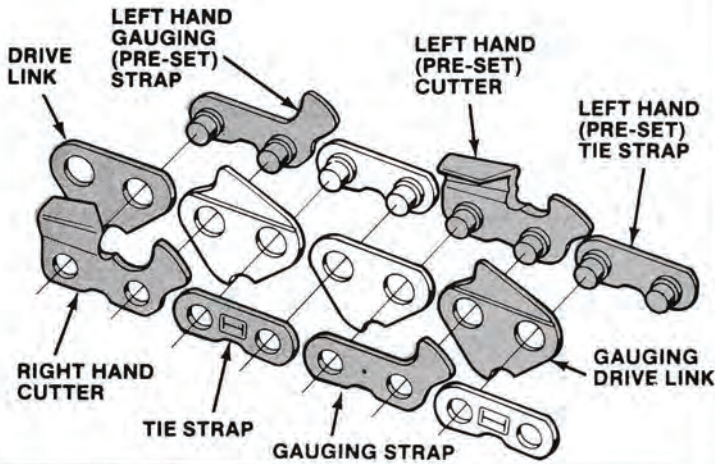

CORRECTIVE FILING

IF SOME CUTTERS ARE LONGER THAN OTHERS, FILE THEM BACK TO THE LENGTH OF THE SHORT CUTTERS.

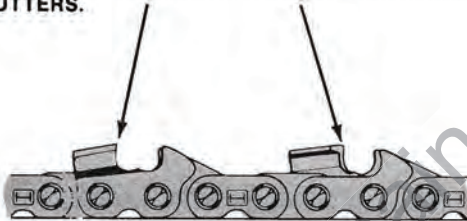

FILING OUT SKID-NOSE WEAR PATTERN

"SKID-NOSE" describes the edge area of teeth which have hit hard objects such as stones, nails, etc., or cut dirt, sand, etc. The "skid-nose" rides the wood surface, keeping the sharp edge out of the wood. The friction at the skid-nose area overheats the cutter steel, and the chain gets "soft." The only way to restore the chain to good condition is to file away all of the skid-nose steel. And, then to adjust all cutters to the same length. As this may be tedious to do by hand-filing, consider having it done by your servicing dealer on an electric grinder.

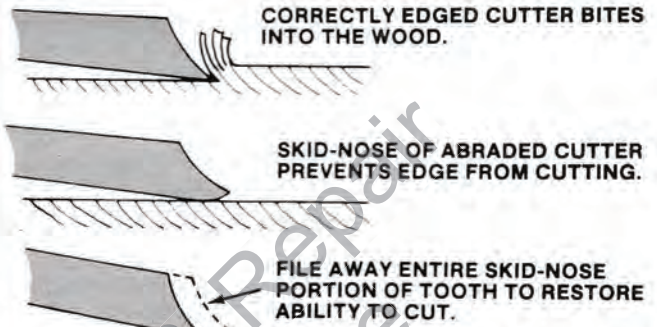

Chain drive tangs must have sharp points to clean sawdust from the bar groove, and bar groove must be deep enough for the tangs to clear bottom all the way around bar. (Every fourth or fifth tang resharpened will do the job as the chain wears.)

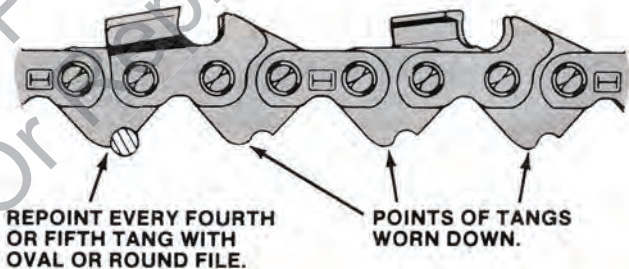

REFILE ANY TEETH HAVING ONE OR MORE OF THESE FAULTS



Forward Hook
Chain will grab and jerk, producing rough-cutting. Caused by excessive downward filing pressure, or tip of file held too low on tooth.



Back Slope
Chain resists entering wood. Scrapes instead of cuts. Causes excessive heat and wear to bar and chain. Caused by lowering handle end of file or holding file too high on tooth.

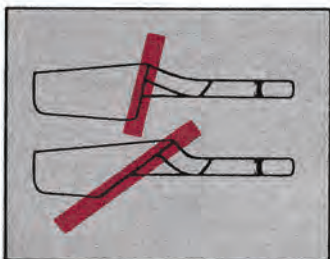

Improper Top Plate Angles
Blunt angle requires too much feed pressure to cut. Too sharp an angle causes binding. Produces a rough cut, robs power from saw, and increases bar wear. Caused by holding file at wrong angle or letting it drift or rock during the stroke.

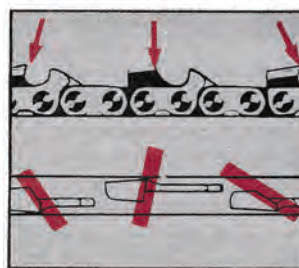

Cutters Filed at Non-Matching Angles or Lengths
Chain will not cut at its best. May cut off line or "run" to one side. Drag will slow down engine. Caused by letting filing angle or pressure vary from tooth to tooth, or filing one side of chain differently from the other.



Thin Feathered Edges
When they almost immediately break off, you have a dull chain. Usually found on chain filed with a hook (see "Forward Hook"). Caused by pressing down too hard on file.

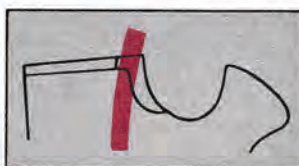

Blunt Cutting Edges
Although edge is durable, it won't cut properly. Scrapes wood, robs power, and produces dust instead of chips. Caused by holding file too high on face of tooth.

RAKER (DEPTH GAUGE) CLEARANCE

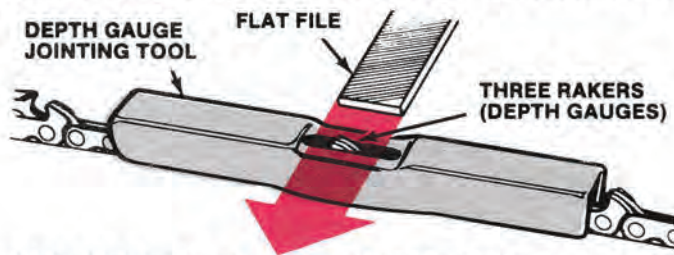

SUGGESTED RAKER CLEARANCES

TYPE OF WOOD	DEPTH	TOOL NUMBER
HARDWOOD OR MIXED HARDNESS	.025"	D-92631-C
STRICTLY SOFTWOOD	.030	D-92632-A

1. Depth gauge tools available for Raker III™ chain are listed above. You should also have a 6" flat file.
2. Every time the chain is filed, check one or two of the rakers. Fit the tool over the chain so a set of three rakers projects up into the slot in the tool (see illustration) and the tool protects the tooth from the file. File flush across the slot. If you take off any metal from the rakers, file all the rakers on the chain.
3. If the rakers are too high, the chain teeth will get too shallow a bite; if too low, the chain will cut too deeply into the wood and the saw will grab and jerk.

GUIDE BAR MAINTENANCE

The guide bar should be cleaned periodically. Use a putty knife or stiff wire to clean packed sawdust out of the chain grooves. Also clean out the chain oil holes so that oil can flow freely to the chain. Rotating the bar top-for-bottom on the saw every day or two helps to equalize the wear.

SAWDUST SHOULD BE CLEANED FROM GUIDE BAR GROOVE, AND THE OIL HOLES SHOULD ALSO BE CLEANED.

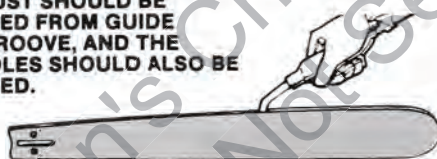

Laminated construction bars can not be welded. They *must be replaced*. Sprocket nose bars in the PT series can be fitted with replacement sprocket nose assemblies when necessary. The nose sprocket bearing is good as long as it turns smoothly and freely. Examine the bar rails. If burred or feathered, file the edges smooth. Small straight cracks in the rails probably have little effect on performance, but rails with hooked cracks will cause trouble. If the bar rails are burned blue it indicates either that the rails were pinched together or that the chain was run with too little oil or under too much pressure.

NOTE

Do not use any guide bar which is bent out of shape. Have bent bars straightened, if possible, or replace them.

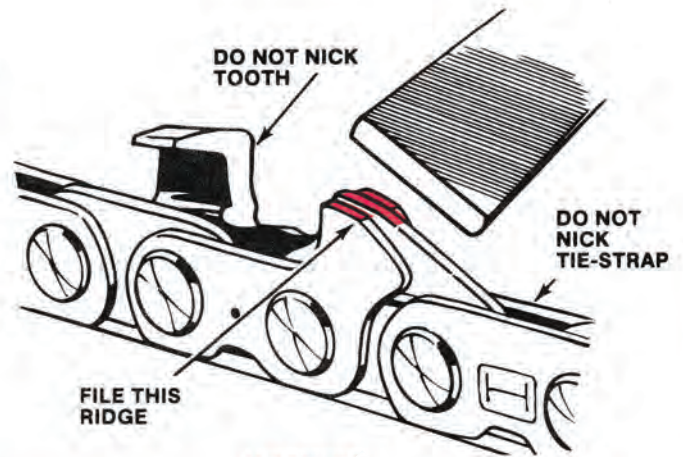

WARNING

Do not exceed the raker clearances recommended in chart. With these raker clearances, Raker III saw chain is smooth-cutting. If the clearance is increased beyond the recommended settings, the chain becomes rough-cutting and "grabby," losing the advantage that it has over other chain designs in the reduction of kickback reactions.

If the rakers are not filed to the same clearance, you may get the same poor results as from non-uniform cutters. Non-uniformity causes slow cutting, and the saw often goes off line.

4. After the rakers have been filed, they should be contoured to their original pattern. When doing this with the flat file fit the depth gauge tool over the tooth on an angle to protect the cutting edge.



NOTE: SAFE-T-TIP® device has been remounted

WEAR PATTERNS IN GUIDE BAR GROOVE AND BAR RAILS

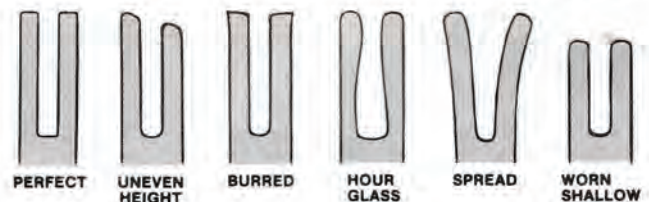

Most of these will cause the chain to flop over sideways and either not cut at all or cut in a curve. Sometimes the bar rail will be exposed to one side and will hang up against the side of the cut so the chain cannot feed.

CLUTCH AND SPROCKET

WARNING

Proper disassembly and repair of the clutch is so important to the life of the engine and the safety of the operator, that all clutch service should be done by an experienced repairman equipped with the required special tools. DO NOT disassemble the clutch unless you are a competent small engine mechanic and have the proper clutch service tools.

1. The owner should clean the clutch drum and sprocket and the surrounding area daily, at the same time as he is cleaning and remounting the bar and chain. At these times, a check should be made to see that the clutch drum turns freely and smoothly.
2. Whenever a new chain is to be installed, the drive sprocket should be replaced also, for full life expectancy of the chain. At these times, the clutch bearing should be checked and either replaced or repacked with grease (see below).
3. The clutch requires full inspection and service at 100 hour intervals. You are again reminded that this should be done by a competent serviceman. If any of the bearing needles are missing, have developed flat spots, or are burnt or bent; or if the bearing cage or inner race is worn or scored, change the entire bearing complement. If the bearing seems to be in good shape, repack it with a small amount of Homelite® All-Temp Multi-Purpose Grease #17193 or a lithium base grease.
4. Clutch trouble symptoms are: a) failure to disengage (chain rotates during idling and the idle cannot be adjusted low enough to stop chain rotation); b) slipping so much that the saw cannot cut; and c) chattering during a load.



WEAR IS VISIBLE ON SPUR TYPE

CHAIN WEAR PATTERN ON SPROCKET TEETH

5. Causes of clutch trouble may include: a) overheated, stretched springs; b) worn or cracked spider or clutch plate; c) worn or broken clutch shoes; d) oil, dirt or grease on the clutching surfaces; e) worn, bent, cracked or scored clutch drum; f) dry or worn bearing and g) worn sprocket.

CHAIN BRAKE MAINTENANCE

All surfaces of the chain brake assembly in the drive case cover, as well as the drive case and clutch area of the saw, should be cleaned before each day of cutting. Then the user should make a careful inspection for wear of the brake mechanism parts. If there is any detectable wear, the saw should be brought to your servicing dealer for inspection. The chain brake checkup should be included in any 50-hour service work performed by your dealer.

REMEMBER

There is no test available to assure effectiveness of the chain brake.

AIR FILTER AND CYLINDER COVER

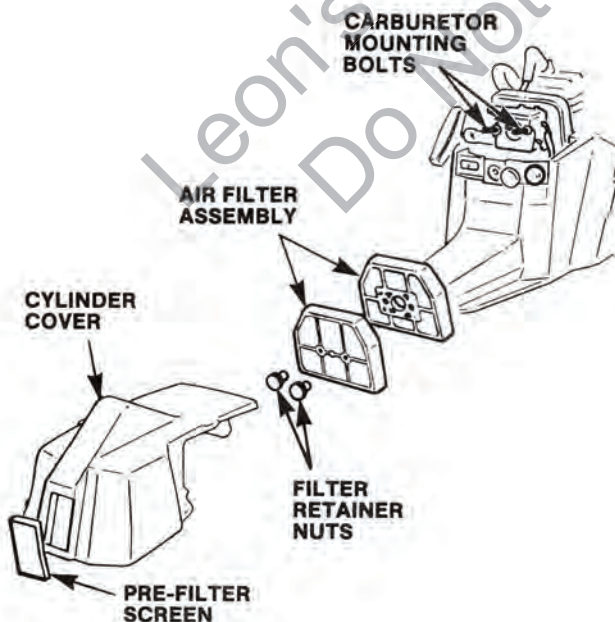

1. For access to the cylinder and carburetor area, loosen the three screws holding the cylinder cover and remove the cover.
2. Rinse the prefilter screen located on the back of the cylinder cover, in a non-oily solvent. Replace the prefilter if it becomes torn. Prefilter snaps out of cylinder cover.
3. Before removing the air filter from the carburetor, blow or brush as much loose dirt and sawdust from around the carburetor and chamber as possible.

NOTE

Always clean the air filter before making any mixture adjustments of the carburetor.

4. The air filter is retained by two filter retainer nuts. Remove nuts and lift filter off of carburetor mounting bolts.
5. A light cleaning can be given to the filter assembly by tapping it against a smooth, flat surface to dislodge most saw dust and dirt particles.
6. For a more thorough cleaning, separate the two halves of the filter element.
7. Rinse the filter halves in a non-oily solvent and dry before assembly. NOTE: If an air hose is used for drying, blow through both sides of the screens.
8. Assemble filter halves.
9. Reinstall air filter.

CARBURETOR ADJUSTMENT

Air filter assembly has been removed for illustrative purposes. Air filter must be in place while making carburetor adjustment. The HI-LO carburetor adjustment needles protrude through a grommet that is located in the cylinder cover so that fine tuning can be done. The Idle Speed Screw can be adjusted by removing the plug located in the cylinder cover.

PRELIMINARY SETTING TO GET ENGINE STARTED

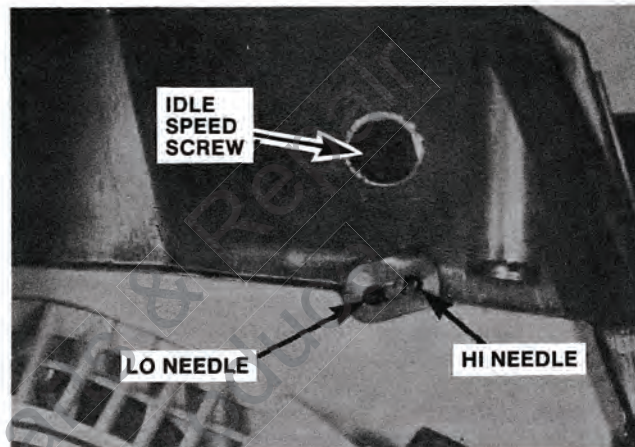
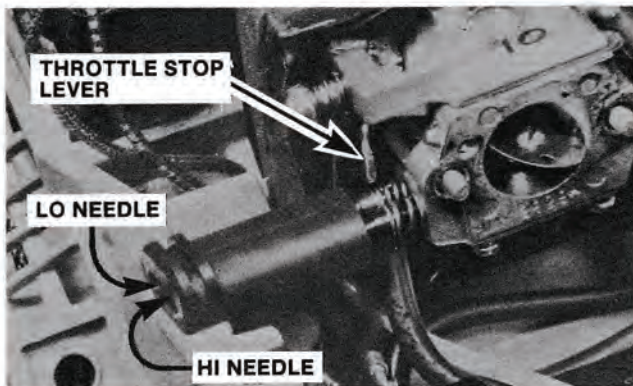

NOTE

Be sure the throttle trigger is unlatched or you will not be able to make the IDLE speed adjustment with the IDLE speed screw.

1. Remove the cylinder cover by loosening the three captive screws. Note the position of the Idle Speed Screw against the throttle stop lever.
2. Back out the Idle Speed Screw (turn counterclockwise) until you can see a gap between the lever and the screw. Then turn the Idle Speed Screw clockwise until it touches, but does not move the lever. Now turn the screw clockwise 3/4 to 1 turn more to move the lever (which will crack the throttle valve open just a bit).
3. Close both HI and LO mixture needles very slowly to the right (clockwise) until each gently bears against its seat.
4. The idle mixture adjustment to the left is called the "LO" needle. It meters the flow of fuel in the idle system. Open (turn counterclockwise) the "LO" needle 1 to 1 1/8 turns.
5. The main mixture adjustment is called the "HI" needle. It meters the fuel drawn through the main jet for full power operation. Open (turn counterclockwise) the "HI" needle 1 to 1 1/8 turn.
6. Push out idle speed plug and install cylinder cover.

WARNING

When the above preliminary adjustments have been made, the chain will almost always rotate at high speed when the saw is started. Keep the chain in the clear and hold saw down properly.

FINAL ADJUSTMENTS

Some adjustments may be necessary once the engine is at operating temperature.

CAUTION

"HI" speed needle adjustments less than one (1) turn open will produce excessively high no load speeds which could cause internal engine damage. Do not operate the saw at high speed no load conditions.

1. **FOR IDLING:** Start and run the saw until it is at full operating temperature. Then turn the LO NEEDLE slowly to the left and then back to the right while noting the effect on the idle speed. At this point, DO NOT adjust the IDLE SPEED SCREW to change the speed, but set the LO NEEDLE at the highest speed obtainable. That setting provides the best mixture.

Now you can adjust for the proper idle speed with the IDLE SPEED SCREW. The proper speed is slightly below that which would cause clutch engagement and chain rotation, but fast enough that the engine idle will be stable at any altitude about 2700 (rpm).

2. **FOR ACCELERATION:** Pull the throttle trigger to accelerate the engine. If the engine falters or hesitates from low to high speed, turn the "LO" needle slightly to the left (counterclockwise). Recheck acceleration. When satisfactory acceleration is achieved, the idle speed screw may need readjustment.

3. **FOR FULL POWER:** This main adjustment is made with the HI NEEDLE. Start a cut in a log at full throttle and gradually apply so much pressure to cut that the clutch slips and the chain stalls momentarily. If the engine falters, release the trigger and open the HI NEEDLE 1/4 turn to the left (or to where the engine can carry a full clutch-slipping load).

If, during the above trial, the engine did carry the full load, you have to turn the HI NEEDLE to the right (clockwise) to make the engine falter on purpose. And then repeat paragraph 3.

After the adjustment has been made for full power you may notice a change in the idling or accelerating ability. If so, make any necessary slight readjustment of the LO NEEDLE setting to get a smooth acceleration and idle. Then readjust the IDLE SPEED SCREW for optimum idle speed. Reinstall plug in idle speed hole.

NOTE

Never exceed the 12000 RPM maximum no load speed.

FUEL SYSTEM MAINTENANCE AND TROUBLE CHECK POINTS

1. **FUEL FILTER:** Periodic inspection of the filter is required. If the filter appears to be dirty, cleaning may not help the felt material and replacement of the filter is recommended.
2. **FUEL LINE:** Deformation and cracking of the line, resulting in an air leak, will cause lean operation (excessive high speed but no power) which cannot be compensated for by carburetor adjustment. You can see all of the fuel line except the portion going through the chamber wall. The fuel line can be seen after cylinder cover has been removed.
3. **FUEL TANK VENTING:** The fuel tank vent is a rubber check valve located in the top of the tank behind the fuel and primer return lines. Venting is done by a duckbill type valve. A foam filter covers the valve. A clogged filter or inoperative valve will result in sequence where the engine will start and run at full power, then almost immediately run lean and quit. After such sequence you can test by slowly loosening cap until air is let into the tank. Then if the engine again starts willingly but runs lean, have both the filter and the valve replaced.

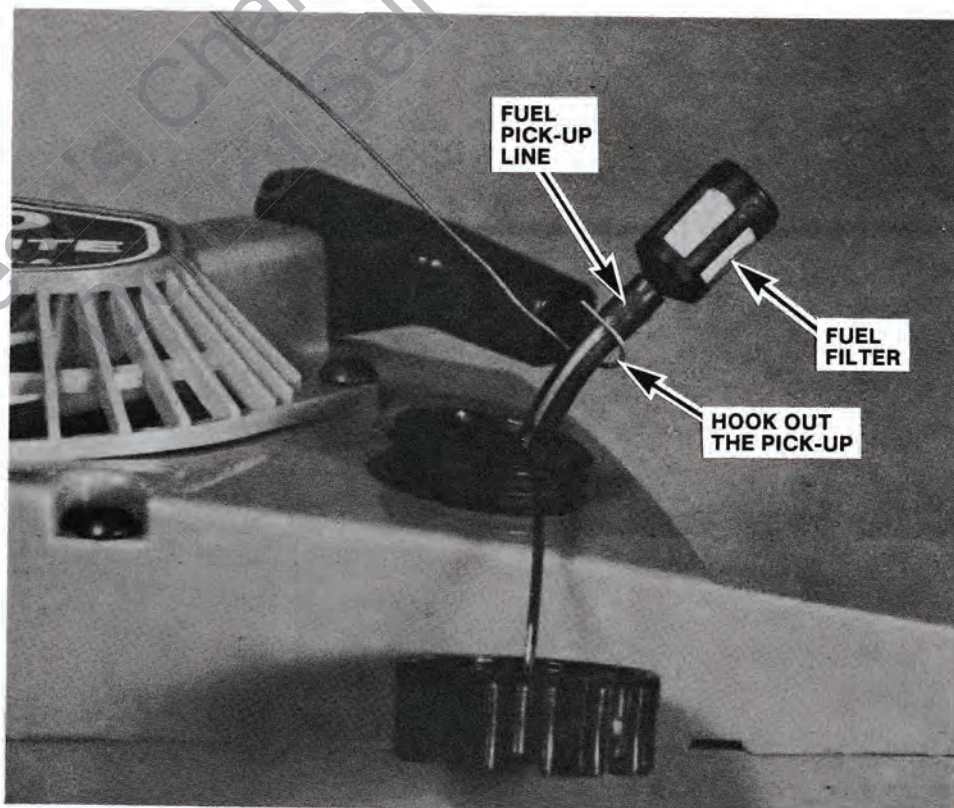

CHAIN OIL SYSTEMS

The automatic oil pump is a positive displacement type pump operated through gears driven off the crankshaft assembly. The automatic oiler can be adjusted to different flow rates ranging from 6 to 11 cc per minute at 9000 RPM average cutting speed.

OILER ADJUSTMENT: The oil pump adjuster is located below the right rear corner of the cylinder. Insert a screw driver into opening next to cover mounting screw on the adjuster. Turn to the desired setting.

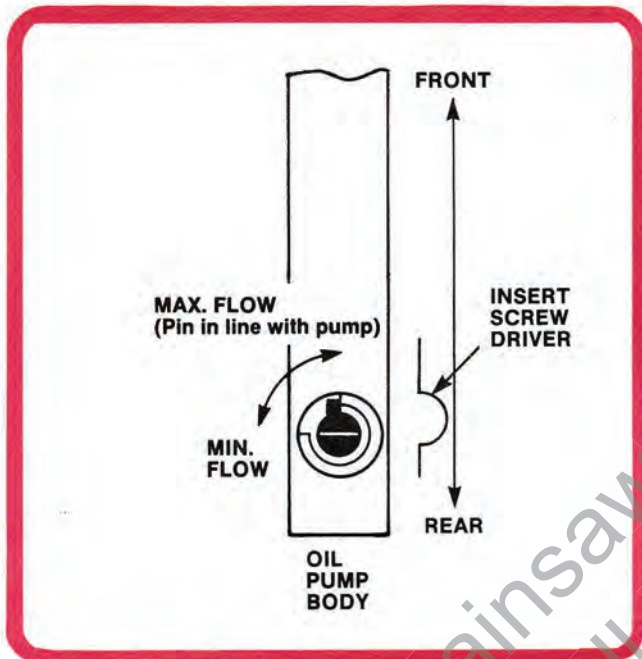

NOTE

The oil tank vent is located in the top of the oil tank. This vent should only be serviced by a Homelite Servicing Dealer.

If you suspect that the oil pump output is low, have the saw checked by a Homelite Servicing Dealer before further use.

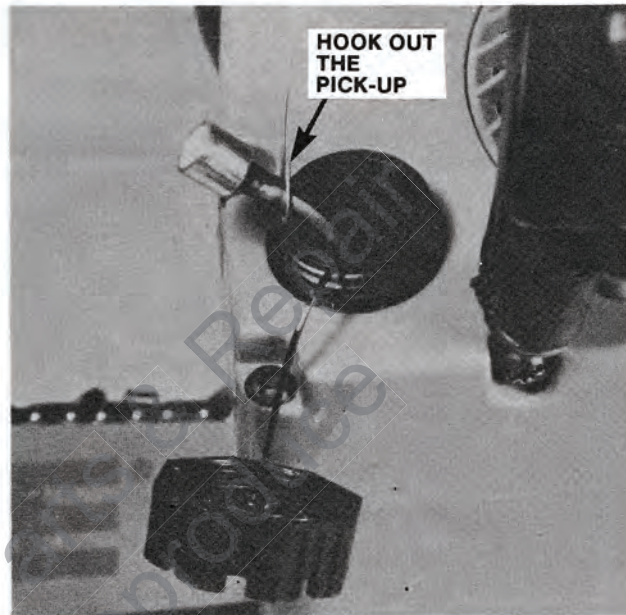

CHECK OIL PICK-UP

Turn saw over onto the fill-up position and remove the oil cap. There is one pick-up line in the oil tank. Hook the oil pick-up line and pull it out through the oil filler hole, (stretching the line will be necessary). Check the oil strainer. If clogged, remove the strainer assembly from the oil pick-up line and clean thoroughly in solvent or with compressed air. Reinstall into oil line.

IGNITION, COOLING AND EXHAUST SYSTEMS



CHAMPION RCJ-6Y



.025" FIRING GAP

THE SPARK PLUG can be left in the engine unless the engine becomes hard to start. Then do as follows:

1. First check that the tank is full of fresh and properly prepared fuel. Stale gasoline, water or dirt in the fuel may be the trouble rather than poor spark.
2. Unscrew and remove the cylinder cover to expose the cylinder and spark plug. Pull the spark plug boot off the spark plug and remove the plug.
3. To get going right away, install a new Champion RCJ-6Y Spark Plug (or its equivalent of the same heat range) having a .025" (0.63 mm) electrode gap.
4. Failed spark plugs can often be restored to dependable firing condition by careful regapping and cleaning.

WARNING

Spark plugs can be scraped clean by hand, or hydrohoned, but sand-blast or power-brushed plugs should not be used in this engine, no matter how thoroughly washed.

Restore the firing gap to .025" by carefully bending the side electrode towards the center. When cleaning the plug, scrape the deposits from the insulation, and clear the space up inside of any debris, carbon or bridging. Then file or scrape the electrodes down to bare metal, and square up their edges to induce the spark to jump.

MUFFLER

The large box type muffler reduces the exhaust noises to a noticeably lower range of sound. The front discharge exhaust outlet is covered by a spark arrestor screen and a baffled cover plate which directs the exhaust gases away from the operator. Since the spark arrestor screen may deteriorate or burn out occasionally, a replacement should be kept on hand for maintenance.

In order to properly inspect the cylinder exhaust port or clean the cylinder fins, you must first remove the muffler assembly. The muffler is held in place by three long bolts retained by locking nuts. Unscrew the nuts and remove the muffler. When reassembling, replace the muffler gasket between the muffler and the cylinder.

CYLINDER COOLING FINS: These and the surrounding air space should be kept clean and open. Whenever you have the cylinder cover and muffler off the saw, give all exposed surfaces a thorough cleaning. Poke gently between the cooling fins with a stick or wire brush to clean right down to bare metal, or blow with air. But do not use a cleaning solvent because it may attack the insulation of the ignition components.

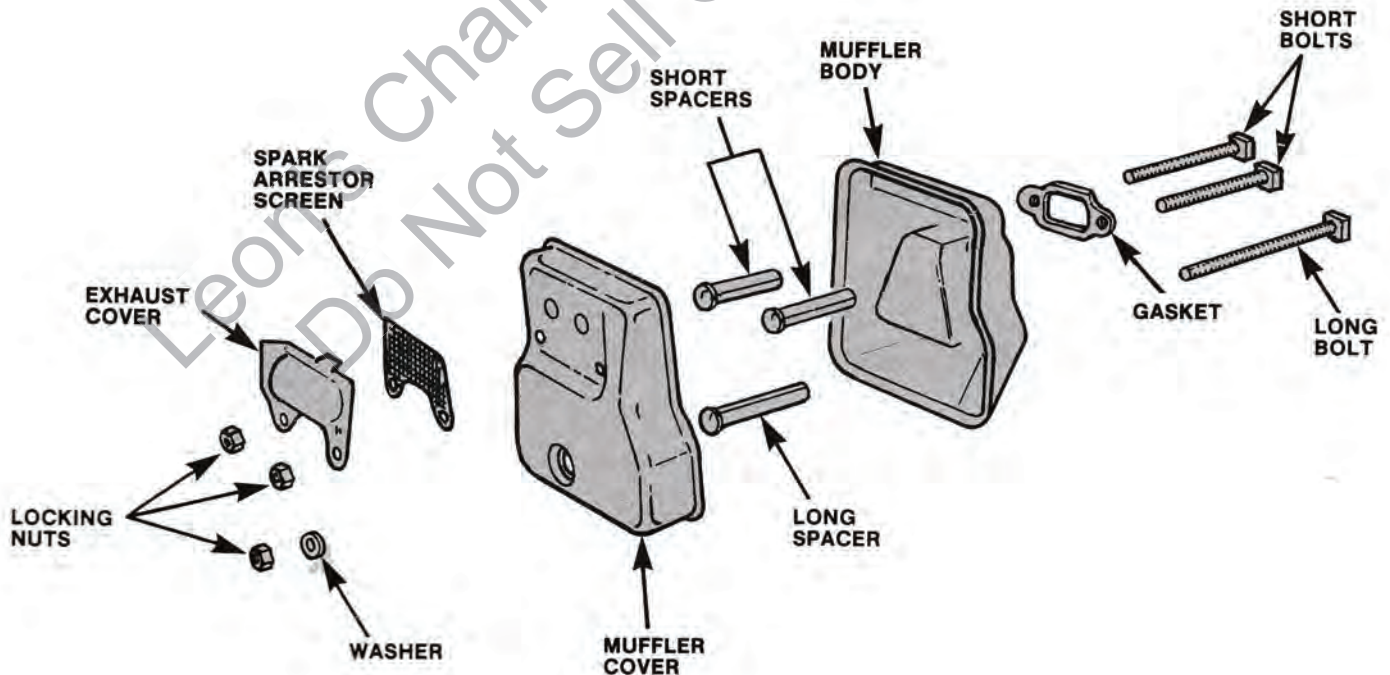

STARTER REPAIRS

The starter rope is subject to stretching and fraying, and eventually to breaking. Increasing the rewind tension and replacing the starter rope are things the owner may find convenient to do himself.

1. Remove the guide bar and chain.
2. Remove the three slotted torx head screws which hold the starter fan housing to the engine housing.
3. **TO ADD MORE SPRING TENSION:** If the grip does not rewind all the way to the housing and stay in place, it may need another turn of tension. Note the rounded notch in the edge of the pulley. Pull out the grip about one foot and hold the pulley from rewinding. Turn the pulley to locate the notch at the rope entry hole in the housing. Hook up a loop of rope between the housing and the pulley. Grasp the loop and wind one turn tension (or more if necessary) in a clockwise direction. Hold pulley from turning. Pull the rope back out through the hole.

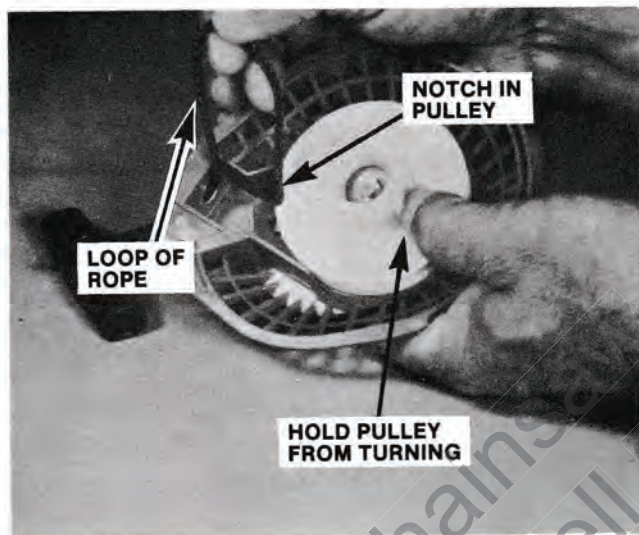

4. **DISASSEMBLING TO REPLACE THE STARTER ROPE:** If the old rope did not break, hold the pulley from turning and cut the rope. Then let the pulley turn slowly until there is no longer any spring torque on the pulley.

WARNING

Put on safety glasses and gloves before removing the pulley.

- a) Remove the slotted hex head plastite screw and the large flat washer from the pulley post (inside pulley hub).
- b) Grasp the toothed pulley hub. Slowly pull the pulley straight off the pulley post.

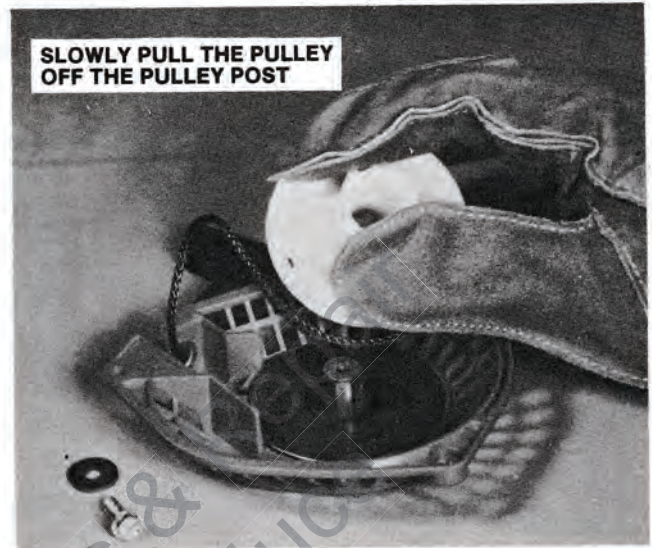

CAUTION

The starter spring in its protective retainer rests in the spring recess of the starter/fan housing. Do not dislodge this spring and retainer, because the spring can inflict injury should it fly out of its retainer. If this spring is broken, it can be replaced by your Homelite servicing dealer or factory service center.

- c) Remove all of the old rope.
5. **TO REBUILD WITH NEW ROPE:**
 - a) Clean the post and pulley. Inspect pulley for wear (rough spots, sharp edges) which could fray or cut the rope. Smooth such spots out with a file or knife blade.
 - b) Tie a simple knot tightly right at one end of the new rope. Push the unknotted end through rope hole in side of pulley and draw rope out between the pulley rims.
 - c) Thread the rope through the eyeleted hole from the inside of the starter housing. Then put the starter grip onto the rope. Knot this end of the rope as you did the other.
 - d) Set both knots by dipping in acetone type cement or nail polish. Trim excess rope right near the knot. Pull knots into pulley recess and into starter grip.
 - e) Clean the pulley post.
 - f) Hold the pulley in position to mount on post. Turn the pulley clockwise (not the rope) until all but about 10-inches (25 cm) of the rope is coiled onto the pulley.
 - g) As you slide the pulley onto the post, locate the pulley notch at the housing eyelet. Pull up a loop of rope there for setting the starter prewind tension.
 - h) Lightly twist the pulley to and fro until the inner loop of the spring engages the locking cam of the pulley, and pulley settles into place.
 - i) Put the large washer in the pulley recess and start the plastite screw into the pulley post. Use care to start the screw threads into the old threads—**DO NOT CROSS-THREAD**. Make screw snug but not overly tight since this is plastic.

- j) Pick up the loop. Let pulley and loop turn together—wind four turns of tension clockwise onto pulley. Pull out the starter grip so the rope runs straight from the pulley out of the housing eyelet.
 - k) If there is not enough spring tension to draw the grip into place against the housing, follow Step 4 to increase the tension.
6. REASSEMBLY: Fit fan housing roughly into place. Press starter housing lightly against the engine and slowly pull out the starter grip a few inches until the starter pawls move out to engage the starter pulley. Now fasten the housing together with the three slotted torx head plastite screws. Again be careful not to cross-thread the plastite screws. Tighten screws securely.



OFF-SEASON STORAGE

1. Remove bar and chain and clean them thoroughly. Let chain dry and store in a small container of engine oil to prevent rust. Oil the dried bar and wrap it in oiled paper.
2. Prepare the engine internally for storage. Drain as much fuel from the saw tank as possible, then start and run the engine until it runs dry and quits. Remove the spark plug to pour in a teaspoonful of a rust inhibitor product or a detergent oil. Install the spark plug and crank the engine enough times to distribute the oil over the cylinder and piston walls as a vapor.
3. All local regulations for the safe storage of fuel supplies must be observed. Non-stabilized fuel supplies should be used up in other equipment or discarded.
4. Clean all foreign material from the outside surfaces of the engine. The finish can be preserved with a coat of auto wax.
5. Store the saw in a well-ventilated place where it is inaccessible to children and away from corrosive agents such as garden chemicals and de-icing salts.

CHAIN CAN BE STORED IN OIL

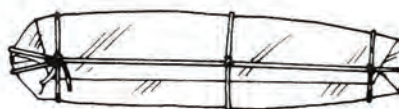

WRAP BAR IN OILED PAPER



FILL IN THIS INFORMATION FOR YOUR RECORD

MODEL NO. _____
UT NO. 10681
SERIAL NO. HNI 840249
DATE OF PURCHASE 5 20 93
NAME OF DEALER Blumenkes
ADDRESS Rosendala via
INVOICE NO. 231

NOTICE

Technology changes with the times. Homelite strives not only to create new products, but also to refine and improve existing designs. By contacting our manager of customer relations (address on back cover) you can learn of any improvements or new devices which have been developed since you purchased your chain saw.

NOTES

Co.1 A01546

Leon's Chainsaw Parts & Repair
Do Not Sell Or Reproduce

SERVICING DEALER INFORMATION

For the location of your nearest Homelite Servicing Dealer in the contiguous United States, Hawaii, Puerto Rico, and the Virgin Islands.

CALL: 1-800-242-4672
1-800-521-5165 N.C. Res. only

NOTE: Only Dealer Location Information can be obtained at this number.

HEADQUARTERS

HOMELITE DIVISION OF TEXTRON INC.
P.O. BOX 7047
14401 CAROWINDS BOULEVARD
CHARLOTTE, N.C. 28241

OVERSEAS OFFICES

NETHERLANDS

HOMELITE TEXTRON
DIVISION OF TEXTRON ATLANTIC
(HDQS. — Europe, Africa and Middle East)
Haverstraat 24
2153 GB Nieuw Vennepe
The Netherlands

ENGLAND

HOMELITE
DIVISION OF TEXTRON LIMITED
UNIT 22
Hither Green Trading Estate
Clevedon (Nr. Bristol)
Avon, BS 21 6XU England

FRANCE

HOMELITE TEXTRON
UNE DIVISION DE TEXTRON
S.A.R.L.
Z.I. du Vert-Galant
Rue du Chateau/Rue de la Garenne
95310 Saint-Quen-L'Aumone
France

AUSTRALIA

HOMELITE DIVISION OF TEXTRON PACIFIC LIMITED
HEADQUARTERS
22 Terra - Cotta Drive
Blackburn, 3130
Victoria, Australia

CANADIAN OFFICES

HOMELITE

DIVISION OF TEXTRON CANADA LIMITED
1850 55th Avenue
Lachine, Quebec, Canada
H8T 3J5

Unit #10, 3260 Viking Way
Richmond, British Columbia
V6V 1N6

16520-111th Avenue
Edmonton, Alberta
T5M 3V8

595 Canarctic Drive
Downsview (Toronto)
Ontario, Canada
M3J 2P9

691 Malenfant Blvd.
Dieppe Industrial Park
Dieppe, New Brunswick
E1A5T8

HOMELITE **TEXTRON**

Homelite Division of Textron Inc.